

COMMISSIE VOOR HYDROLOGISCH ONDERZOEK TNO
COMMITTEE FOR HYDROLOGICAL RESEARCH TNO

VERSLAGEN EN MEDEDELINGEN No. 21
PROCEEDINGS AND INFORMATIONS Nr. 21

GROUNDWATER POLLUTION



**COMMISSIE VOOR HYDROLOGISCH ONDERZOEK TNO
COMMITTEE FOR HYDROLOGICAL RESEARCH TNO**

**VERSLAGEN EN MEDEDELINGEN NO. 21
PROCEEDINGS AND INFORMATIONS NO. 21**

GROUNDWATER POLLUTION

**PROCEEDING OF
TECHNICAL MEETING 31**

CONTENTS

I. Introduction to the Theme Groundwater Pollution, C. VAN DEN BERG	9
II. Characteristic Examples of the Natural Groundwater Composition in The Netherlands, C.R. MEINARDI	12
III. Interaction-Mechanisms in Soil as related to Soil Pollution and Groundwater Quality, F.A.M. DE HAAN	34
IV. Nitrogen, Phosphate and Biocides in Groundwater as influenced by Soil Factors and Agriculture, J.H.A.M. STEENVOORDEN	52
V. Pollution of Soil and Groundwater from Land Disposal of solid Wastes, J. HOEKS	70
VI. Some Quality Aspects of Artificial Recharge in sandy Soil of the Veluwe, F.J.J. BRINKMANN, J. HRUBEC and B.C.J. ZOETEMAN	87

AUTHORS

- Dr. C. VAN DEN BERG** Institute for Land and Water Management Research, Wageningen.
- Ir. C.R. MEINARDI** Government Institute for Water Supply, Voorburg.
- Dr.ir. F.A.M. DE HAAN** Agricultural State University and Coworker of the Institute for Land and Water Management Research, Wageningen.
- Ir. J.H.A.M. STEENVOORDEN** Institute for Land and Water Management Research, Wageningen.
- Dr.ir. J. HOEKS** Institute for Land and Water Management Research, Wageningen.
- Dr. F.J.J. BRINKMANN, et al.** Government Institute for Water Supply, Voorburg.

INTRODUCTION TO THE THEME GROUNDWATER POLLUTION

C. VAN DEN BERG

Director, Institute for Land and Water Management Research, Wageningen, The Netherlands

Pollution of groundwater has been known in the world for a long time mainly in the extreme form leading to salinisation of irrigated land. Already more than 4000 years ago the phenomena have been written down in the chronicles of Mesopotamia, though probably it was not known that the real background of the misery originated from the rising of saline groundwater because of irrigation.

Some hundreds of years later the Babylonian king Hammurabi enacted minute rules regarding irrigation with the purpose to prevent these calamities and indirectly he created then one of the oldest legislations to protect the environment. As well groundwater pollution as soil pollution was fought against. In modern irrigation practice the same problems emerge regularly and the related phenomena of salt water intrusion in the Dutch delta are well known.

Still, nowadays when speaking about pollution we do not think first of these types of "natural" pollution. The attention is much more focussed on the excess of ill-used matter distributed in the biosphere by human activities and leading to pollution of air, soil and water. It is of interest to point out here the close relationship of these types of pollution, a consequence of the movement of air and water.

Our concern particularly is water as a means of distribution. Let us therefore consider part of the hydrological cycle, beginning with precipitation.

Gaseous components distributed over wide areas by air movement are regularly brought to the earth's surface by precipitation. Though the concentration of soluble products in this water is low, in the last 30 years a definite increase occurred of sulfates, nitrogenous components and heavy metals, whereas the pH has decreased.

In the topsoil then an increase of concentration takes place because the precipitated water evaporates there for the greater part. The remaining solution will absorb soluble matter from the topsoil or from solid waste disposed on the land.

This solution moves downward and its concentration in dissolved components not only depends on the absorption of matter from pollution sources but also on the chemical, physicochemical and biochemical processes, so important in the non-saturated zone of the soil. The salt concentration of the moving solution continuously changes by adsorption and desorption of cations, solution and precipitation of salts and by biochemical processes. Moreover the changes in concentration of the different components are by no means equal.

The material remaining in the soil as a result of adsorption, precipitation and formation of complex compounds creates the problem of soil pollution. The dissolved components finally added to the groundwater with the infiltrating water are the main source of groundwater pollution. The proportion between adsorption by the soil and removal to the groundwater for several components is largely governed by the type of vegetation. The same rules hold for artificially supplied river water, waste water and sprinkling water.

The distribution of dissolved salt in the subsoil then is governed by groundwater flow. During flow the concentration of different components may change by soil processes, though their intensity is low as compared to that in the topsoil. Other changes in concentration are brought about by intrusion of seawater, infiltration of river water and the uptake of components from geological formations. For the Netherlands the wide-spread peat layers particularly are important as a source of some soluble components as nitrogen- and phosphorus compounds.

It is important to bear in mind that the precipitation surplus, added to the groundwater, together with the intruded outer water will appear as surface water after a certain time. Under Dutch circumstances this period varies from some days to some hundreds of years. But for the greater part of the precipitation surplus this period will be limited to 5 to 10 years. The quality of surface water will therefore largely be governed by the quality of the groundwater when the surface water is little polluted by direct discharge of polluting matter or waste water. This situation occurs in many rural districts with minor population concentrations.

The phenomena described above are well known. Their presentation seemed desirable in order to underline the relationship of air-, soil-, groundwater- and surfacewater pollution.

What is our knowledge now and how is it possible to arrive at quality criteria of water for different purposes and what are the environmental consequences?

There is a tendency to consider every addition of a component to water over its natural content as pollution. In the Netherlands, where intensive land use has been practiced for a long time already, this consideration is of no use. Still we need limits not to be exceeded for the normal use of water, i.e. groundwater. In that case it is clear that separate groups of compounds and even separate ions must be distinguished, each of them with its own desirable limit.

Because of the complicated history of groundwater, particularly as a result of its intensive contact with the soil, this history *has* to be unravelled for the different groups and ions. Only then it will be clear for instance if groundwater pollution or soil pollution is the main feature.

For groundwater it seems to be the most simple way to set the same limits as is usual for public water supply. From an ecological point of view it is difficult to find the right criteria for groundwater. For the time being it seems to be most important in this respect

to take criteria for surface water as a guide, as groundwater will become surface water within a few years.

Exigences, criteria and standards are measuring sticks of the administration responsible for environmental legislation. Much is still insufficiently known and in the field of groundwater pollution as well as in the field of soil pollution further investigations are needed to analyze accumulation and transport processes in soils and water, and their consequences for the environment. One should wish the administrators Hammurabi's wisdom in choosing the measures to be taken in the complex affair of groundwater- and soil protection.

Considering the papers following, the motto: "Pollution of groundwater" seems to be ambitious. What is presented is restricted to a number of aspects and examples. On the one hand much attention is given to hydrological and soil processes, on the other hand some polluting components are followed along their pathway. One thing they have in common, however: a scientific description of facts and processes is their backbone.

CHARACTERISTIC EXAMPLES OF THE NATURAL GROUNDWATER COMPOSITION IN THE NETHERLANDS

C.R. MEINARDI

Government Institute for Water Supply, Voorburg, The Netherlands

1. USE OF DATA ON GROUNDWATER QUALITY

Data on groundwater composition often form an appreciated tool in hydrological studies as they reflect varying conditions of the groundwater during its existence as such and even before. From the wide range of dissolved substances, however, the hydrologist will usually only pick up a few, which by their typical behaviour enable him to draw conclusions as to the flow of groundwater, the structure of the underground etc. For that purpose an extensive set of mostly graphical procedures (e.g. Piper's diagram) has been developed to allow a relative comparison of water quality data. By these methods differences between various types of water can be recognized, even with only a limited conception of the factors involved in constituting one special type.

Direct interest in groundwater quality is also felt by its consumers, e.g. a water supply company recovering groundwater. Again, only a few out of many properties of the water are regarded. Those components being (potentially) harmful to use are of special concern. Therefore the water properties studied in direct connection with public water supply need not necessarily correspond with those investigated by the hydrologist. It should be noted, however, that factors influencing the relevant type of groundwater are important, for they partly determine the present and future management of the water works. Need for this more profound knowledge is tempered by the fact that groundwater quality is generally changing at a slow rate, leaving time to follow trends.

A thorough understanding of the groundwater composition always meets with the difficulty that research in quite different fields of study is necessary. No such investigation will succeed without some knowledge of among others geology, hydrology and meteorology, chemistry and physics or even microbiology. In the present paper an attempt will be made to, at least partly, elucidate the most important factors affecting groundwater quality in the Netherlands.

2. PHYSICAL AND CHEMICAL PROPERTIES OF GROUNDWATER

Groundwater contains in general a great quantity of different substances in solution. Some are relatively abundant which means that their content is in the range of mg/l or sometimes even g/l, they are called major components of the groundwater quality. Other

compounds or elements are present in smaller amounts (they have to be counted in micrograms per liter ($\mu\text{g/l}$) or even less), they are called minor or trace constituents. In normal practice only major components are determined; for the determination of trace elements very sensitive and costly techniques are needed. Hence in the Netherlands some thousands of analyses of major components of groundwater from borings all over the country are available, whereas measurements as to minor constituents can be found only incidentally. A description of the groundwater composition in the Netherlands should therefore in the first place be based upon the available analyses of major components.

The bulk of dissolved substances in groundwater is formed by the positively charged ions Ca^{++} , Mg^{++} , Na^+ , K^+ and sometimes NH_4^+ and the negative ions Cl^- , SO_4^{--} , NO_3^- (in some cases also NO_2^-) and HCO_3^- . Positive and negative charges should balance each other, thus giving an indication on the reliability of the analysis. It is recommended that an analysis should at least permit to draw up this ion-balance. Other parameters of importance for water supply purposes and consequently often included in normal analyses are the content of the dissolved gasses O_2 and CO_2 , total iron content, manganese content, hardness, pH, chemical oxygen demand and electrical conductance.

In recent times some attention is given to certain trace elements in groundwater for reasons of public health, but the majority of the determinations of minor constituents is done for hydrological reasons. Stable and radio-active isotopes of hydrogen (^2H and ^3H), carbon (^{13}C and ^{14}C) and oxygen (^{18}O) are used to give additional information on age and origin of groundwater.

When interpreting data on the quality of groundwater one should always bear in mind that analyses may not fully represent the groundwater sampled. This may particularly be caused by changes occurring in the composition of water during sampling and transport. Sampling has to be done carefully to make sure that the water is indeed discharged from the right aquifer. A more serious attack on reliability is formed by the fact that gasses dissolved in groundwater are generally not in equilibrium with atmospheric conditions. This fact may notably result in an evasion of CO_2 from the sample and in an uptake of O_2 and these changes will have consequences for the values of some other parameters (e.g. iron and manganese, pH) as well. The analysis itself does not give an indication whether such changes have happened or not.

Finally it should be noted that water analyses may be inaccurate due to mistakes made in the laboratory.

3. BASIC FACTORS GOVERNING GROUNDWATER COMPOSITION IN THE NETHERLANDS

It is sometimes overlooked that the first factor involved in the composition of groundwater is the quality of water recharging the groundwater system. In many cases this original composition will be strongly influenced by changes in quality occurring in the underground, but mostly some of the original features can still be recognized (fig. 1).

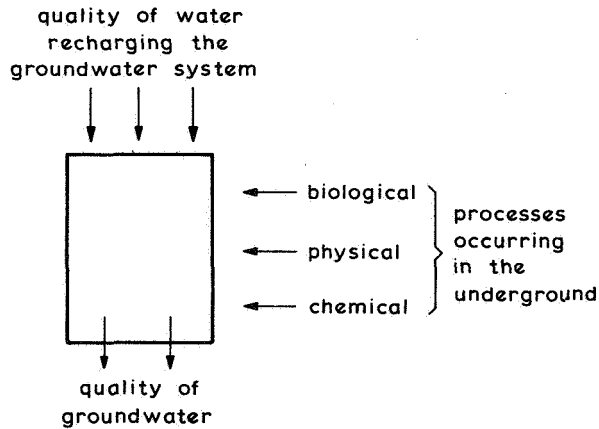

Fig. 1. Composition of groundwater.

In the Netherlands groundwater may be recharged by rain, by sea or by rivers (or, in general, surface water), by waste water or by a combination, each of them with their own characteristic composition.

Seawater has a fairly constant and well-known composition (see table 1), although near the coast and especially in estuaries variations may occur due to dilution with fresh water.

Each river will, by nature, have its own composition of water, dependent on the drainage basin. However, when the drainage basin is densely populated and industrialized, pollution may have a strong influence. The river Rhine is the most important for the Netherlands. The natural composition of Rhine water (the 1870 level) was investigated by Molt (1961), whereas recent trends are attentively watched by water supply companies (see table 1).

Rain water has a low content of dissolved substances, its composition depends on meteorological conditions and on the distance to the seashore. A careful and long-term investigation of rain water quality has been carried out by Leeftang (1938); more recent figures are given by Conrads and Buisman (1973). The values of some parameters measured in rain water have increased locally and recently due to increasing air pollution. When rainfall recharges the groundwater, part of the dissolved substances may be derived from aerosols deposited on trees, land surface etc: and thereafter leached by rain. Especially near the coast the wind may carry droplets of nebulized seawater. However, the same factor is true in some degree for a capturing device to sample rainwater.

Waste water may have a very much varying composition depending on the quality of the water supplied and on the kind of waste (domestic or industrial) etc. An indication of the composition of domestic waste water is given by Scholte Ubing (1972). It should be noted that domestic waste water traditionally contains more Na^+ and Cl^- than the original water.

TABLE 1
COMPOSITION OF THE WATER OF DIFFERENT
SOURCES OF GROUNDWATER RECHARGE

	MEAN OCEAN WATER	RHINE WATER (YEARLY MEAN)			NON OR SLIGHTLY POLLUTED RAIN WATER			DOMESTIC WASTE WATER IN EXCESS OVER SUPPLIED WATER
		IN 1870	IN 1930	IN 1970	AT 440m FROM COAST	AT 3000m FROM COAST	AT 48000m FROM COAST	
CHLORIDE (Cl ⁻) IN mg/l	19,000	12	60	160	1.6	7.5	4.0	20 to 100
SULPHATE (SO ₄ ⁻²) "	2700	35	42	76	5.6	4.3	4.6	± 50
HYDROGEN CARBONATE] (HCO ₃ ⁻) "	142	160	161	158	3.7	2.6	2.6	
NITRATE (NO ₃ ⁻) "	0	11.2	3	12	± 1	± 1	± 1	
CALCIUM (Ca ⁺⁺) "	400	50	63	76	2.5	1.7	1.7	± 30
MAGNESIUM (Mg ⁺⁺) "	1,350	10	10	12	1.7	1.2	1.0	± 20
SODIUM (Na ⁺) "	10,500	5	26	75	7.9	3.9	2.0	20 to 80
POTASSIUM (K ⁺) "	380	5	5t.10	5t.10				± 10
AMMONIUM (NH ₄ ⁺) "	0	0	0.3	1.6	0.5	0.5	0.5	± 100

Changes in quality of water occurring in the underground are complex insofar that in most cases a combination of elementary processes has been involved which cannot easily be segregated. In schematising this complex of changes into a series of biological, chemical and physical processes one has to be aware of the danger of oversimplification. This is even more true for a further subdivision. One has to realize that microbiological processes occurring in the underground are often incomparable with laboratory experiments under well-defined conditions. Nevertheless a schematisation is necessary to get at least a rough idea of what is possible and what is not, even though it may not be perfect at all points.

(Micro)biological processes may take place under aerobic or anaerobic conditions.

Aeroby. Plants assimilate CO₂ and H₂O using energy derived from sun radiation:

CO₂ + H₂O + energy → (CH₂O) + O₂. The energy contained in the organic compound (CH₂O) is essential for the plant's life. It is freed by a second process which may reyield CO₂ and where O₂ is used. This last process is preponderant in soil, radiation being negligible there. It will cause an increase of gaseous CO₂ in soil air, if compared with the atmosphere. Similarly, as long as groundwater contains dissolved O₂, organic matter in the soil or in the water may be mineralised by micro-organisms using O₂ and yielding CO₂ and H₂O as main products. Generally the O₂ content will decrease and the CO₂ content will increase in the direction of the groundwater flow. Under aerobic conditions also, a mostly limited amount of SO₄⁼ and a sometimes considerable quantity of NO₃⁻ or NO₂⁻ may be formed by biological activities in the soil.

Anaeroby. When oxygen is absent, organic matter may be broken up simultaneously with a reduction of nitrate, sulphate or carbon dioxide.

This can be schematically expressed as follows:

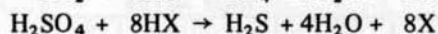
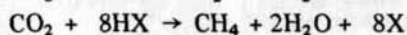
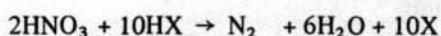

These processes (Barker, 1956) are called denitrification, methane fermentation and sulphate reduction respectively. The compound HX acts as a hydrogen donor and is, after delivery of hydrogen, changed into one or more compounds X. In most cases HX is some kind of organic substance, yielding oxidized forms X, which may be, at least partly, gaseous CO_2 . In a following step X may act as a hydrogen donor, until ultimately only CO_2 is formed. In many cases the above processes are preceded and accompanied by various fermentational processes breaking up more complex organic compounds which may then serve as HX. It has to be noted that one of the end-products under natural conditions will almost always be CO_2 , paradoxically even at methane fermentation.

A very important physical process to influence groundwater quality is evaporation and plant transpiration (evapotranspiration) which may occur during recharge of groundwater. Evaporation may be conceived as a distillation process resulting in an evasion of H_2O and a condensation of the remaining solution. Hence, theoretically all concentrations of dissolved substances have to be multiplied by a certain factor to be computed from the ratio between the total amount of water supplied and the remaining amount of water after evaporation took place (e.g. this factor is equal to the ratio rainfall/recharge).

Evaporation in a certain area is strongly dependent on both meteorological conditions and the kind of vegetation in that area. Reliable values of evapotranspiration are difficult to obtain directly. A water balance study over 13 years for the Veluwe area resulted in a mean value of rainfall of 840 mm/year (which is somewhat higher than the average in the Netherlands) and a mean value of evapotranspiration of 450 mm/year. Differentiation as to various types of vegetation according to Penman's theory (1952) yields the approximate values of table 2.

As at least shallow groundwater is generally flowing at a certain rate, attention should be given to physical processes such as mixing and transport. These phenomena can be described for a great part by theories on hydrodynamical dispersion which, however, only allow to reach quantitative results in fairly simple cases. In a previous study (Meinardi, 1975) it has been attempted to compute with some success the chloride distribution in the underground of certain parts of the Netherlands.

A special case is mixing induced by molecular diffusion in stagnant groundwater. Such cases may occur when fresh-water bearing sediments are overrun by a transgressive sea, or the reverse, when layers with saline groundwater are covered by a lake with fresh water. This subject has been studied by Volker (1961) for the IJsselmeer area in the Netherlands.

The phenomena of diffusion and of dispersion are of special interest when the distribu-

TABLE 2 THE RELATION BETWEEN TYPE OF VEGETATION, EVAPOTRANSPIRATION AND CONDENSATION FACTOR COMPUTED FOR THE VELUWE AREA FOR 1952-1965 (RAINFALL 840 mm/year)

TYPE OF VEGETATION	MEAN POTENTIAL EVAPOTRANSPIRAT. IN mm/year	CONDENSATION FACTOR = RAINFALL/RECHARGE
OPEN WATER	680	5.3
PINE FOREST	510	2.6
DECIDUOUS FOREST	410	2.0
HEATHER	460	2.2
BARE SOIL	200	1.3
AGRICULT. AREAS	410	2.0
TOTAL AREA OF WATER BALANCE STUDY (450 km ²)	450	2.2

tion of chloride is concerned. The first reason is that great differences in chloride concentration may occur over short distances and the second that chloride is hardly ever involved in biological and chemical processes, which are relatively more important for most other dissolved substances.

When soluble material is present in aquifers it may be resolved by groundwater. However, this possibility should not be overestimated. Fluvatile sediments, forming aquifers flushed by fresh groundwater will not contain much soluble matter anymore. An exception should be made for salts brought in by man (for example de-icing salt or fertilizers). The solution of gasses in water may for equilibrium conditions be described by Henry's law, which states that the rate of dissolving is equal to the partial pressure multiplied by a specific absorption factor. It has to be remarked that not atmospheric conditions are prevalent for groundwater, but partial pressures of various gasses present in the soil air. Particularly, the partial pressure of CO₂ may take much higher values in soil than in the atmosphere and consequently CO₂ concentrations in groundwater may considerably increase if compared to concentrations in rainwater.

Groundwater containing CO₂ will be able to dissolve limestone (calcium carbonate) whenever it is present in sediments, whereas groundwater without CO₂ will do so only in relatively very small amounts.

The following equilibrium holds:

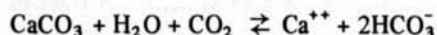

The fact that equilibrium exists, implies that not all CO₂ is used. If groundwater (in the absence of CaCO₃) contains more than the equilibrium concentration of CO₂, it is

called aggressive towards calcium carbonate, therefore it has a tendency to dissolve CaCO_3 when the occasion occurs. Calcium carbonate will precipitate if for some reason CO_2 evades from the groundwater (e.g. under changing pressure conditions). Under normal conditions the pH of groundwater will largely depend on the relation between the values of the CO_2 , HCO_3^- and CO_3^{2-} concentrations.

Another chemical process to change groundwater considerably if conditions are favourable, is cation exchange. Generally, this phenomenon may occur if the values of cations (Ca^{++} , Mg^{++} , Na^+ , K^+) in groundwater do not correspond with the values of exchangeable cations present as part of the sediments in the aquifer. Practical cases are:

1. Fresh groundwater flows through an aquifer which some time before contained saline water (e.g. marine sediments). The Ca^{++} ions in the groundwater will decrease and the Na^+ ions will increase at about the same rate (in milli-equivalents).
2. Brackish groundwater flows through sediments having contained a more fresh water before. Now Na^+ ions in the groundwater will decrease and the Ca^{++} ions will increase. This type of groundwater flow occurs when seawater is intruding landinwards or when the interface between fresh and brackish groundwater rises.

One of the most crucial parameters of groundwater suitable for water supply is the iron content, which largely determines the type of treatment to be given before the water is supplied to the consumer. It is for this reason that processes in the underground related to iron will be treated in some detail.

Iron compounds may be found underground both in solution as a component of the groundwater and in solid form as part of the aquifer. The relation between dissolved and precipitated forms can for a large part and at least qualitatively be explained by theories on reduction – oxidation (redox) conditions in aqueous solutions. Redox conditions for a certain solution are expressed by the value of the redox potential Eh (in Volt) of that solution, which can be measured (in practical cases not without difficulties). Now if Eh and pH of a certain solution, being at equilibrium, are known, as well as all compounds involved (both in dissolved and in solid form), theoretically all concentrations of different ions in solution can be computed. Generally, oxidized forms of involved elements are present at high and reduced forms at low redox potentials. For a number of common compounds of iron such an Eh-pH diagram, also called a stability field diagram, is given by Hem (1970). However, the use of this diagram (fig. 2) is severely limited by the following practical reasons:

1. The determination of Eh is not a standard procedure at the analysing of water samples, as in practical cases this measurement for a number of reasons often will give erroneous results. Furthermore both pH and Eh are rather sensitive to changes in composition which may occur during sampling and transport of the water.
2. The solution has to be at equilibrium and this is not always the case.
3. The given diagram is valid only if no other solid forms than those mentioned occur and

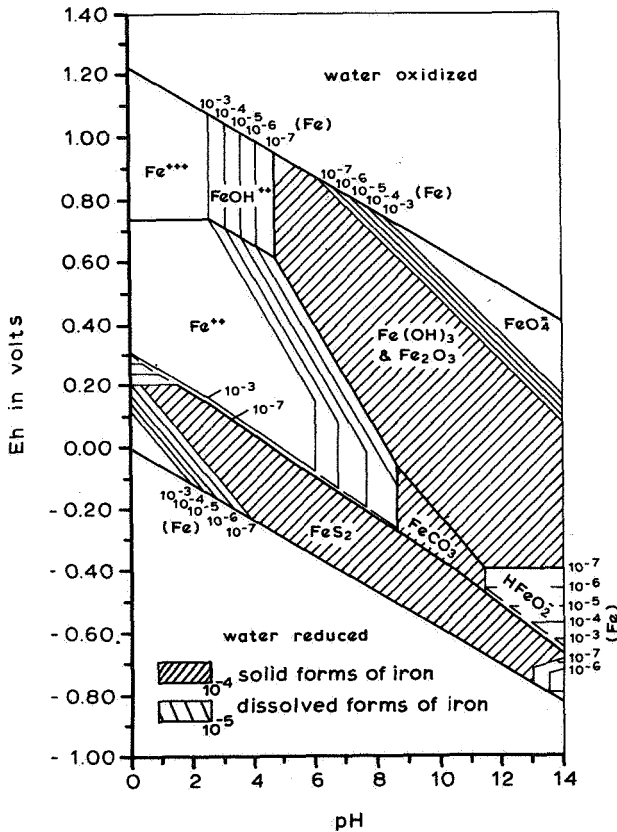

Fig. 2. Eh-pH diagram after HEM for solid and dissolved forms of iron (concentrations in mol/l); activity of sulfur species 96 mg/l as SO_4^{--} ; activity of carbon dioxide species 61 mg/l as HCO_3^- .

also if no other dissolved compounds of iron are available. However, both conditions may not be fulfilled. Iron precipitates may take a different form. Especially if organic matter is present, this may form soluble complexes with iron in considerable amounts.

Nevertheless, these stability diagrams are very valuable in making possible a qualitative description of the behaviour of dissolved iron in relation to some other components of groundwater. What has to be done is, in fact, to estimate redox conditions without knowing redox potentials.

If groundwater contains dissolved O_2 or NO_3^- , it can be remarked that these compounds represent oxidized forms. The redox potential may be high and as sometimes these conditions may prevail in the upper layers of soil, in combination with a low pH, iron can go into solution in Fe (III) form. However, in the normal range of groundwater

pH ($6 < \text{pH} < 9$) not much dissolved iron will be found at high Eh as can be deduced from the diagram.

Another indication as to the redox conditions of groundwater is given by the quantity of CO_2 to originate in the underground and present both as free CO_2 and as HCO_3^- ions. Under aerobic conditions in the underground, dissolved oxygen will be depleted by biological life using the energy contained in (CH_2O) and inducing both an increase in CO_2 and a decrease of the redox potential. Also micro-organisms may use energy derived from other redox reactions implying again a decrease of Eh and, as a result of metabolism, an increase of CO_2 . Anaerobic conditions will lead to a further lowering of Eh. As has been shown before, in nature usually CO_2 will be freed by micro-biological processes under anaerobic conditions. It can be concluded that generally in the direction of the groundwater flow an increase in CO_2 concentration may be remarked which usually implies a decrease in Eh. At a certain point, values of Eh are reached where under normal pH conditions iron in Fe (II) form will go into solution. Beyond this area, in the lowest part of the stability field diagram, conditions are favourable for precipitation of FeS or FeS_2 (pyrite).

As can be seen from the diagram (fig. 2) at $6 < \text{pH} < 8$ there is only a relatively small area where iron will go into solution to a limited extent, thus explaining why concentrations of dissolved iron are usually rather small but also indicating that small changes in the Eh or pH of groundwater may have important consequences as to the iron content.

Finally it can be remarked that quite similar considerations hold true for some other metallic compounds in groundwater and notably for manganese.

Factors determining the concentrations of natural but uncommon isotopes in groundwater will be treated only briefly here. More ample theories can be found in literature (I.A.E.A. 1968, Mook, 1970).

Determinations of the following isotopes have been used in the present investigation:
 Hydrogen: Tritium (^3H)
 Oxygen : Oxygen-18

Concentrations of the stable isotope ^{18}O in groundwater depend mainly on conditions during transport through the atmosphere and on evaporative conditions during recharge. Important factors are mean air temperature and distance to the ocean (the original source of rain). The water of the river Rhine, originating in Switzerland and Southern Germany, shows significant differences with rainfall in the Netherlands (Mook 1968) and this difference can be traced back in groundwater. The relation between values for Deuterium (^2H) and ^{18}O indicates whether groundwater has been exposed to open water evaporation or to plant transpiration during recharge.

The radio-active isotope ^3H (half-time 12.5 years) will decay and not be recharged once the water is underground, its concentration will therefore give an indication of the age of groundwater if at least initial concentrations are known.

4. REPRESENTATIVE AREAS TO CHARACTERIZE GROUNDWATER QUALITY

As has been made clear in the preceding chapter some of the most important factors influencing groundwater quality are closely related to conditions shortly before and during recharge. This general rule is particularly true for the situation in the Netherlands, because here indeed recharging water is of strongly varying quality and also because of a rather simple structure of the subsoil, resulting in relatively few changes to occur in the underground.

Most of the fresh-water bearing aquifers in the Netherlands are replenished by rainfall. However, in the area of the big rivers (Rhine and Meuse) and also in the western part of the country recharge by surface water occurs. Recharge by surface water became really important after the creation of polders. As the Netherlands is a densely populated and an industrialized country, recharge of groundwater by waste water may locally be important. Actual intrusion of seawater takes place in a small zone along the coast due to a landward gradient of the piezometric levels. More important, however, is chloride brought into various aquifers during transgressions of the sea in geological history. Almost everywhere in the Netherlands marine sediments can be found at one depth or another and these sediments, of course, once contained seawater, which in many cases has not been fully flushed away yet.

Another reason why conditions during recharge of groundwater are so important with respect to quality lies in the structure of the underground of the Netherlands. Although the topsoil may differ from one place to another, the deeper layers of the underground consist mainly of fluviatile onconsolidated sediments of considerable thickness, the coarser parts of which form very good aquifers. Consequently, fresh groundwater is mostly of relatively recent age and flows through mainly sandy layers. This implies that leaching of soluble parts of aquifer and processes connected with very low rates of groundwater flow are not very important.

A good insight in the groundwater quality of the Netherlands can be obtained by investigating a few representative areas, differing from each other with respect to the quality of recharge water and to the nature of the topography and topsoil. Hydrological conditions of these areas have to be well-known, or at least it should be possible to estimate the groundwater flow patterns. The following areas (see figure 3) have been selected:

Veluwe: Recharge by rainfall; sandy topsoil

Betuwe: Recharge by Rhine (partly); clayey topsoil

Isle of Dordrecht: Recharge by Rhine; clay and peat

Dunes at Katwijk and lysimeters at Castricum: Recharge by rainfall; sand and clay.

Emphasis has been laid on areas where presumably groundwater of natural quality, not disturbed too much by recent pollution, can be found, although part of the groundwater will be influenced by at least agricultural use of recharge areas. Moreover, the

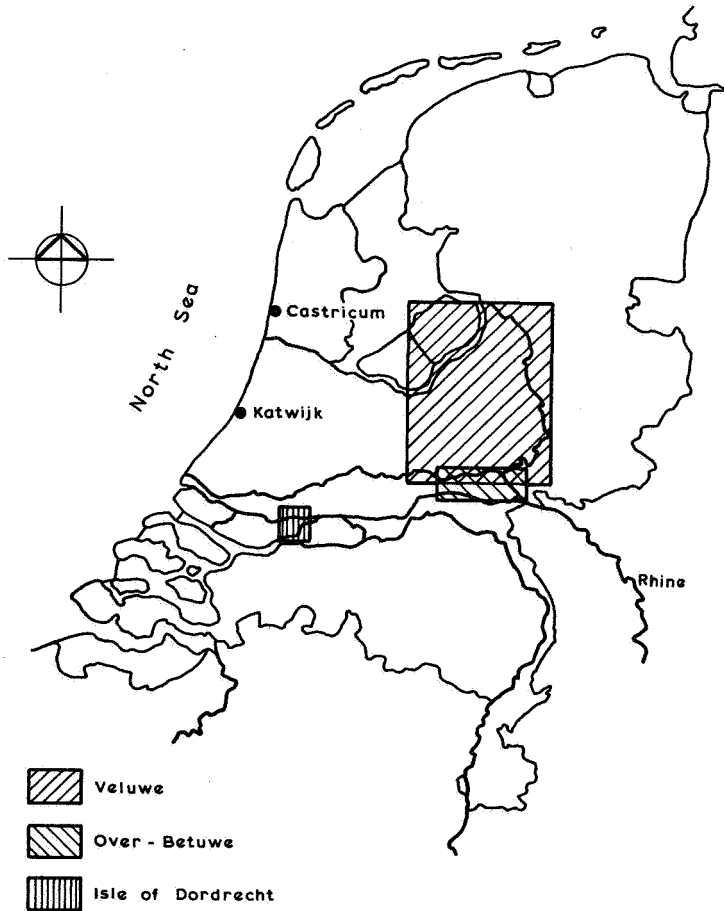

Fig. 3. Representative areas investigated.

pollution of the river Rhine in the last 100 years cannot be overlooked in areas where groundwater is recharged by Rhine. No attention has been paid to areas where the groundwater is preponderantly brackish or saline. They are left out of scope, because the accompanying problems need a different and rather complicated investigation.

5. RESULTS

1. The representative areas to characterize groundwater quality have been chosen firstly with regard to different types of water recharging groundwater, viz. two types of rain water (near the coast and more inland) and two types of water of the river Rhine (of natural composition and of recent polluted composition). In all areas investigated at least

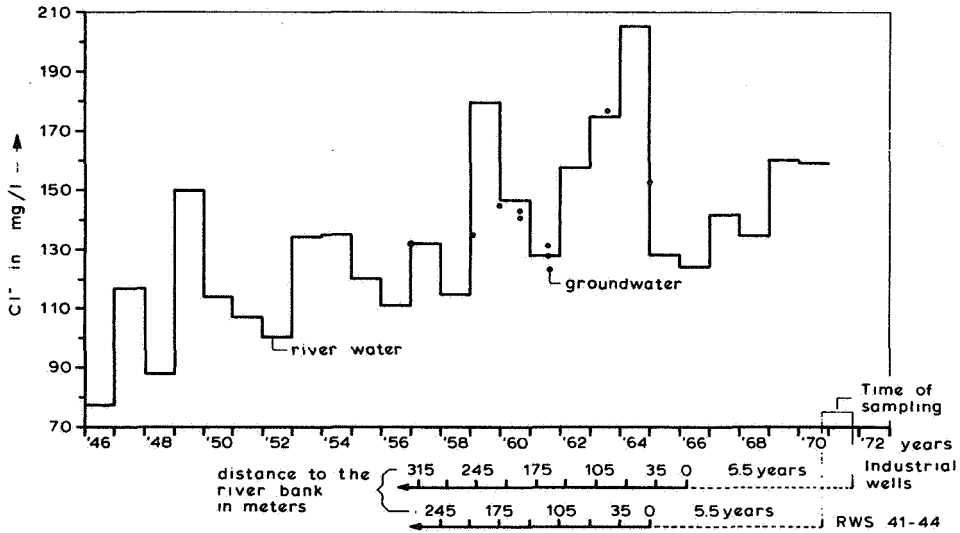

Fig. 4. Chloride concentrations of river water (yearly mean) and of groundwater in the shallow aquifer at Dordrecht as a function of distance to the river and time of sampling (the groundwater flows perpendicular to the river with an actual velocity of 35 m/year).

TABLE 3
ANALYSES OF GROUNDWATER SAMPLES FROM THE MAIN AQUIFER OF THE VELUWE
(SEE THE COMPOSITION OF RAIN WATER IN TABLE 1)

NUMBER OF BORING	SCREEN DEPTH IN RELATION TO LAND SURFACE	DATE OF COLLECTION	Ca ⁺⁺ (mg/l)	Mg ⁺⁺ (mg/l)	Na ⁺ +K ⁺ (mg/l)	NH ₄ ⁺ (mg/l)	Cl ⁻ (mg/l)	SO ₄ ⁻ (mg/l)	NO ₃ ⁻ (mg/l)	HCO ₃ ⁻ (mg/l)	CO ₃ ⁻ (mg/l)	FREE CO ₂ (mg/l)	pH	HARDNESS (meq/l)	Fe (mg/l)	Mn (mg/l)	SiO ₂ (mg/l)	COD(mg/l KMnO ₄)	EL.COND. μS/cm
26H-145	149	13-12-67	26.6	1.1	12	0.23	11	11.5	0	88	0	4	7.6	1.4	1.3	0.22	12.4	2	150
27B-155	132	26-9-68	26.0	2.4	14	0.3	11	11.1	0	98	0	12	7.1	1.5	0.13	0	16.0	1	160
32G-137	30	6-6-73	31.5	1.3	8.0	0.24	7	6	0.1	107			8.1	1.7	0.25	0.04		5	177
32G-137	100	8-6-73	36.5	4.0	8.0	0.20	8	9	<0.1	134			7.9	2.1	0.45	0.04		7	211
33A-20	108	3-3-53	9.9	1.7	14.8	0	18.7	8	4.3	31	0	16.7	6.6	0.6	0.07	0	13.2	3.6	110
40A-323	84 117	3-3-64	19	2.2	10	0.10	12	4.9	0	67	0	3	7.7	1.2	0.02	0	11.4	1	122

one, but mostly several components of recharge water quality could be traced back in the groundwater composition (see figures 4 and 5 and table 3). Concentrations of Mg⁺⁺, (Na⁺ + K⁺), Cl⁻ and SO₄⁻ reported in table 3 and figure 5 are about twice the values in the recharge water (condensation). In certain areas of the Isle of Dordrecht where the groundwater is directly recharged by riverwater a comparison could be made between the chloride concentrations in groundwater (flowing perpendicular to the river) and river water (see figure 4).

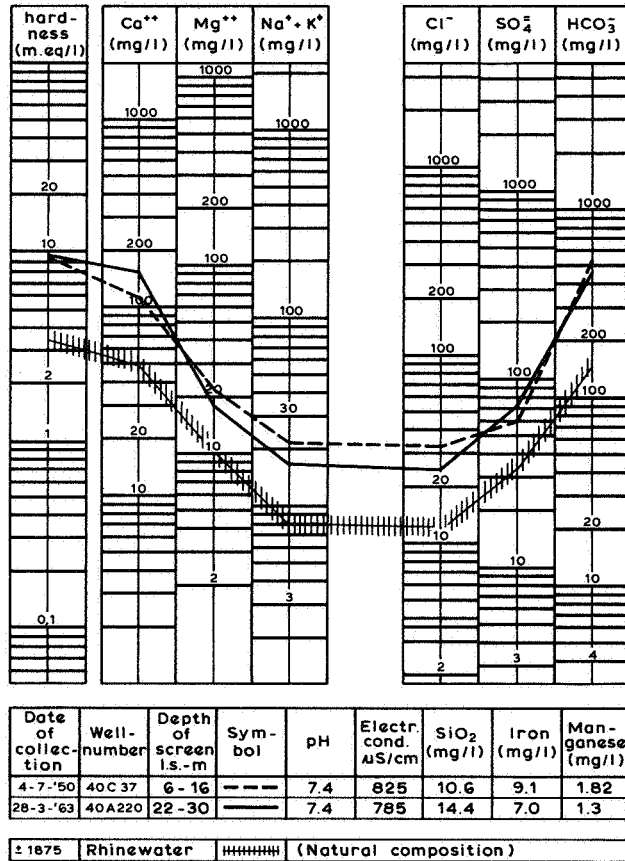

Fig. 5. The effect of condensation on the shallow groundwater in the Over-Betuwe if compared with the natural composition of Rhine water.

The first conclusion is:

No thorough understanding of groundwater composition is possible without knowledge of the quality of water feeding the groundwater system concerned.

2. In addition to substances carried by the recharging water, part of the dissolved compounds in groundwater may be derived from interception of aerosols by vegetation, as is shown by observations at the lysimeterstation of the Provincial Water Works North Holland near Castricum (see table 4). Each lysimeter having the same dimension, the influence of the vegetational cover is obvious. The vegetation of the lysimeters consisted of a bare weeded sandy plain (lys.I), natural dune vegetation (lys.II) deciduous forest (lys.III) and pine forest (lys.IV). However, the effect of interception could not be remarked in groundwater quality outside the dune area.

TABLE 4. LYSIMETERS AT CASTRICUM
DISCHARGED QUANTITIES OF Cl- IONS
(IN kg/ha) OVER PERIODS OF 5 YEARS
AFTER MINDERMAN AND LEEFLANG (1968)

PERIOD	LYS. I	LYS. II	LYS. III	LYS. IV
1947-51	512	615	619	560
1952-56	512	701	732	644
1957-61	566	1023	1008	1128
1947-61	1590	2339	2359	2379
	100%	147%	148%	147%
AVERAGE 1947-61 PER ANNUM	106	156	157	175
AVERAGE 1957-61 PER ANNUM (AT INCREASED GROWTH OF VEGETATION)	113	205	201	225

Locally, substances transported in a natural way but separately from transport by recharge water may affect groundwater composition.

3. Natural recharge of a groundwater system is in many cases accompanied by evaporation of part of the water concerned. Evaporation is usually strongly dependent on the type of vegetation. The result is an increase by condensation of dissolved compounds in the remaining water. This effect could be clearly demonstrated (see figure 5). The only exception concerns the natural isotope ^{18}O forming part of the water molecules.

The third conclusion states:

If evaporation occurs prior to infiltration towards groundwater, all concentrations of components of the infiltrating water except those forming part of the water molecules themselves, should be multiplied by a condensation factor to give the resulting composition of groundwater.

4. The composition of groundwater is further changed in the underground and especially in the topsoil of the recharge areas involved. The representative areas investigated are also differentiated as to the structure of the upper meters of the underground (sand, river, clay, peat). The most spectacular change in groundwater quality if compared with recharge water after condensation, is the relatively enormous increase of Ca^{++} and HCO_3^- concentrations, basically caused by CO_2 production in the underground. According to the equilibrium reaction for solution of solid CaCO_3 by CO_2 bearing water 2 milli-equivalents of HCO_3^- are produced by 1 millimol of CO_2 . Forming of CO_2 results from biological activity occurring under both aerobic and anaerobic conditions in nature. Although all the types of recharge water considered originally contained dissolved

oxygen, implying aerobic conditions in the underground to start with, only part of the groundwater in the Veluwe area down to a depth of about 100 m and drainage water of the unvegetated lysimeter at Castricum clearly indicate aerobic conditions prevailing in groundwater (presence of dissolved oxygen (Veluwe), no significant reduction of NO_3^- and SO_4^{2-} , nearly absence of dissolved iron). Biological processes influence the occurrence of many compounds in groundwater. Generalized data on groundwater of the areas investigated as to different toplayers of the underground can be summarized as follows

a. *Veluwe* (aerated sandy soil, see table 5):

presence of dissolved oxygen;

presence of nitrate (clearly demonstrated in the transition zone);

no reduction of sulphate;

iron concentration lower than 1 mg/l;

estimated concentration of newly formed CO_2 : 10 to 50 mg/l.

TABLE 5
ANALYSES OF GROUNDWATER SAMPLES COLLECTED IN SHALLOW LAYERS
IN THE CENTRAL PART OF THE VELUWE

NUMBER OF BORING	SCREEN DEPTH IN LAND SURFACE	DATE OF COLLECTION	Ca^{++} (mg/l)	Mg^{++} (mg/l)	$\text{Na}^{+}\cdot\text{K}^{+}$ (mg/l)	NH_4^+ (mg/l)	Cl^- (mg/l)	SO_4^{2-} (mg/l)	NO_3^- (mg/l)	HCO_3^- (mg/l)	CO_3^{2-} (mg/l)	FREE CO_2 (mg/l)	pH	HARDNESS (meq/l)	Fe (mg/l)	Mn (mg/l)	SiO_2 (mg/l)	COD (mg/l KMnO ₄)	EL. COND. ($\mu\text{S}/\text{cm}$)
27 A117	35	1-6-65	11.3	1.2	9.0		10	10	0.6	10.4	8.9	0	8.7	0.6	0.07	0.03	9	1	96
27 A117	47	4-6-65	15.1	0.4	8.0		9	6	2.1	33	4.2	0	8.3	0.8	0.12	0.02	9	1	104
27 A117	65	15-6-65	31.3	1.7	8.0		10	6	0.5	97	3.9	0	8.2	1.7	0.61	0.11	8	1	175
32 F 42	19	9-3-56	13.2	0.43	10.8	0.10	11	15.0	0	32.3	1.8	0		0.7	0.32	0	12	6.5	95
32 F 42	66	9-3-56	23.1	1.3	8.9	0.10	11	6.6	0	68.5	4.8	0		1.3	0.47	0.08	12	7.4	142
33 B 56	20	9-2-55	5.7	0.6		0	17	5.8	0	24	0	18.9	6.5	0.3	0.07	0.03		3	44
33 B 56	33	9-2-55	6.6	1.7		0	13	6.6	0	31	0	24.5	6.5	0.5	0.10	0		2.7	70
40 B 245	41.5	12-11-63	2.2	0.7	14.0	0.14	11	10.3	0	15	0	13	6.5	0.2	0.09	0	10	1	58
40 B 245	65	12-11-63	8.0	0.6	10.1	0.08	7	8.2	0	30	0	2	7.6	0.5	0.07	0	48	1	66
40 B 245	85	12-11-63	20.4	2.8	9	0.07	10	4.7	0	79	0	7	7.5	0.7	1.4	0.17	128	1	130

b. *Over-Betuwe* (river clay, see figure 5):

absence of nitrate;

incidental reduction of sulphate;

iron concentration between 1 and 5 mg/l;

estimated concentration of newly formed CO_2 : 20 to 70 mg/l.

c. *Dordrecht* (peat layers, see table 6):

absence of nitrate;

concentration of ammonium higher than 10 or even 20 mg/l;

strong reduction of sulphate;

iron concentrations higher than 15 and even 20 mg/l;

newly formed CO_2 : up to 400 mg/l.

TABLE 6
COMPOSITION OF SAMPLES FROM THE
WELL FIELD OF THE MUNICIPAL WATER SUPPLY OF
DORDRECHT (^{18}O BY PHYSICAL LABORATORY OF GRONINGEN
UNIVERSITY, ^3H BY GOVERNMENT INSTITUTE FOR PUBLIC HEALTH)

NUMBER OF WELL	SCREEN DEPTH IN FEET BELOW LAND SURFACE	DATE OF COLLECTION	Ca^{++} (mg/l)	Mg^{++} (mg/l)	$\text{Na}^+\cdot\text{K}^+$ (mg/l)	NH_4^+ (mg/l)	Cl^- (mg/l)	SO_4^{--} (mg/l)	NO_3^- (mg/l)	HCO_3^- (mg/l)	CO_3^{--} (mg/l)	FREE CO_2 (mg/l)	pH	HARDNESS (meq/l)	Fe (mg/l)	Mn (mg/l)	SiO_2 (mg/l)	^{18}O	^3H pCi/l
6 LABORATORY	15-25	9-4-74	118	144	32	242	64	14	0	476	0	120	6.84	7.1	15.0	0.70	329	-7.44	25
6 IN SITU	15-25	9-4-74								549		180	6.74						
13 LABORATORY	15-25	9-4-74	152	178	30	260	41	21	0	641	0	140	6.76	9.1	19.4	0.80	33.7	-8.56	49
13 IN SITU	15-25	9-4-74								695		191	6.78						
18 LABORATORY	15-25	9-4-74	96	134	84	82	169	647	0	226	0	17	7.34	5.9	3.0	1.4	15.5	-9.79	490
18 IN SITU	15-25	9-4-74								222		10	7.56						
20 LABORATORY	15-25	9-4-74	96	134	71	78	132	381	0	287	0	32	7.17	5.9	4.0	0.80	189	-9.55	520
20 IN SITU	15-25	9-4-74								308		35	7.17						
27 LABORATORY	15-25	9-4-74	167	21.1	36	31.2	54	1.0	0	689	0	170	6.81	10.1	14.4	0.75	35.3	-8.47	66
27 IN SITU	15-25	9-4-74								625		247	6.59						
30 LABORATORY	15-25	9-4-74	94	15.8	74	11.9	141	52.1	0	287	0	34	7.09	6.0	6.0	0.90	20.3	-9.02	570
30 IN SITU	15-25	9-4-74								299		21	7.27						

Samples, represented in table 6, have been collected for two reasons; firstly for the determination of the natural isotopes ^3H and ^{18}O , but secondly to observe "in situ" concentrations of HCO_3^- and CO_2 (i.e. shortly after sampling). Comparing "in situ" analyses with laboratory determinations (i.e. after transport of the samples and some delay in laboratory before analysing), it becomes clear that substantial changes occur in the composition of samples containing high HCO_3^- and CO_2 concentrations. This fact is not surprising as, already during sampling, a visible evasion of gas bubbles (boiling effect) could be noticed. The composition of the gas is not known. Originally it may have consisted of methane and/or nitrogen, but most certainly CO_2 will have been picked up by the bubbles. At the same time, the evasion of gas proves that the gas was not formed under atmospheric conditions (i.e. at landsurface) but somewhere in the underground.

d. *Castricum* (sand, unvegetated lysimeter);

presence of nitrate;

no reduction of sulphate;

newly formed CO_2 : about 45 mg/l;

Castricum (sand, vegetated lysimeters);

reduction of nitrate;

no reduction of sulphate;

newly formed CO_2 : 90 mg/l or more.

TABLE 7
COMPOSITION OF DRAINAGE WATER OF LYSI-
METERS AT CASTRICUM COMPILED FROM DATA
GIVEN BY MINDERMAN AND LEEFLANG (1968)

NUMBER LYSIMETER	PERIOD	Ca ⁺⁺ (mg/l)	Mg ⁺⁺ (mg/l)	Na ⁺ +K ⁺ (mg/l)	NH ₄ ⁺ (mg/l)	Cl ⁻ (mg/l)	SO ₄ ⁻ (mg/l)	NO ₃ ⁻ (mg/l)	HCO ₃ ⁻ (mg/l)
1	1947-1951	48	2.9		2.9	17	14	7.7	138
1	1952-1956	46	2.6	13.3	3.0	17	17	9.9	127
1	1957-1961	45	2.6	12.5	3.1	16	16	8.2	122
2	1947-1951	78	4.5		2.5	32	45	0.1	224
2	1952-1956	86	4.5	28	2.1	43	29	6.8	239
2	1957-1961	87	4.2	30	3.5	47	35	10.6	226
3	1947-1951	81	5.6		3.1	30	99	12	184
3	1952-1956	77	4.4	27	3.2	42	32	0.1	217
3	1957-1961	89	3.8	35	3.9	53	40	0.1	238
4	1947-1951	81	4.9		2.8	36	56	1.5	214
4	1952-1956	106	6.6	45	1.4	74	65	0	270
4	1957-1961	130	7.9	73	1.9	106	97	0	310
ESTIMATE OF RAIN WATER COMPOSITION AT LYSIMETER 1			2	9		13	11	6?	
(RAINFALL/DRAINAGE WATER=1.35)									

It should be noted that the vegetation on lysimeters III and IV was growing at a fast rate during the period of observation. Most likely the composition of the drainage water will change after the vegetation has reached its fully developed state.

The following conclusion can be derived from the investigated areas.

Only in sparsely vegetated areas with an aerated sandy soil aerobic groundwater may be expected to prevail. The denser the vegetation is in recharge areas and the more organic material is present in the subsoil, the higher concentrations of ammonium, dissolved iron and newly formed CO₂ (hardness) will be found in groundwater, derived from these recharge areas.

5. The composition of the groundwater in the main aquifers of Veluwe and Over-Betuwe does not change very much in the direction of groundwater flow, except for a gradual transition to more anaerobic conditions observed at the Veluwe. The same situation can be remarked at the dune-area near Katwijk and may be assumed for the Isle of Dordrecht. However, it is known from other areas (Geirnaert, 1973) that some cation exchange may occur, when fluvial sediments have later been covered by sea for a certain period. Nevertheless, generally the following conclusion holds:

Once the groundwater has passed the shallow or/and covering layers and flows through sandy aquifers consisting of fluvial or in general, terrestrial sediments not many changes in composition are to be expected anymore.

6. Generally, an aquifer system will consist of aquifers of good permeability and layers resisting to groundwater flow. The latter usually contain organic material; decomposition of it will result in production of CO_2 and consequently in a further increase of Ca^{++} and HCO_3^- concentrations, as is indicated by groundwater in the deeper layers of the Isle of Dordrecht.

Decomposition of organic material in deeper layers may lead to changes in groundwater quality.

7. Fluvial sediments in the Netherlands are usually underlain by marine deposits of Older Pleistocene and Tertiary Age, where groundwater is recharged from above. Groundwater flow is rather weak in these layers, because of small gradients in piezometric levels. Analyses of groundwater samples indicate a significant cation exchange resulting in an uptake by the groundwater of Na^+ and a delivery of Ca^{++} ions. Maybe also Mg^{++} concentrations have been affected (see table 8).

TABLE 8
ANALYSES OF SAMPLES COLLECTED UNDERNEATH THE MAIN AQUIFER OF THE VELUWE

NUMBER OF BORING	SCREEN DEPTH (LAND SURFACE)	DATE OF COLLECTION	Ca^{++} (mg/l)	Mg^{++} (mg/l)	$\text{Na}^+ + \text{K}^+$ (mg/l)	NH_4^+ (mg/l)	Cl^- (mg/l)	SO_4^{--} (mg/l)	NO_3^- (mg/l)	HCO_3^- (mg/l)	CO_3^{--} (mg/l)	FREE CO_2 (mg/l)	pH	HARDNESS (meq/l)	Fe (mg/l)	Mn (mg/l)	SiO_2 (mg/l)	COD (mg/KMnO ₄)	EL COND (μS/cm)
26H-36	260	23-8-63	36	4.4	14	0.32	9	5		146			8.3	2.2	0.43	0.05	26.8	5	213
26H-36	303	12-4-46	39	7	41	0.84	32	22		166		3.0	8.0	2.5	6.6	0	9.4	8	356
27C-41	263	13-12-68	33	4.1	20	0.14	12	11		119		0	8.3	2.0	0.04	0.14	21.0	1	196
32G-137	130	13-6-73	27.5	13.0	12.7	0.32	6	6	0.2	170	0		8.0	2.5	0.34	0.03		4	252
32G-137	150	14-6-73	34.5	8.9	13.5	0.31	6	4		169	0		8.0	2.5	0.18	0.02		5	254
32G-137	175	14-6-73	40.0	8.4	11.5	0.29	6	5		176	0		8.1	2.7	0.28			4	265
33D-125	292	15-1-69	11.5	6.0	66	0.28	15	10		192	4	0	8.7	1.1	0.08		13	12	287
33E-185	120	20-2-73	34	5.4	24	1.1	8	2	0.2	187			7.8	2.15	0.67	0.02		15	264
33E-185	150	21-2-73	34	6.0	11.5	0.37	8	<1		150			7.9	2.21	0.30	0.02		7	225

Fresh groundwater flowing at a reduced rate through marine sediments of Older Pleistocene and Tertiary Age will, presumably by exchange, contain increased concentrations of Na^+ and a relatively low content of Ca^{++} (hardness).

8. Much additional information about the origin of groundwater collected at the well

field of the municipal water supply of Dordrecht could be gained from observations as to ^{18}O and ^3H concentrations, which are compiled in table 6.

In groundwater derived from well 6 a concentration of -7.44‰ of ^{18}O (as to S.M.O.W. = Standard Mean Ocean Water) has been observed, indicating that groundwater recharge was mainly formed by local rainfall (Mook, 1970), no water of the river Rhine being present. This observation agrees with purely hydrological considerations, implying recharge by polder water, which will mainly consist of rainfall.

In groundwater collected at wells 18 and 20, ^{18}O concentrations of about -9.5‰ S.M.O.W. are measured, signifying recharge of groundwater by Rhine water (Mook, 1970) not diluted by local rainfall.

Groundwater from wells 13 and 27, which presumably was derived from the Merwelanden, East of the Isle of Dordrecht, contains about -8.5‰ S.M.O.W. indicating a mixture of equal parts of Rhine water and local rainfall. Such a mixing is not unlikely to have occurred in the Merwelanden, consisting of small polders and river swamps.

Groundwater collected at well 30 contains a ^{18}O concentration of -9.02‰ S.M.O.W., leading to the conclusion that it is largely recharged by Rhine water but also for a smaller part (say 25%) by local rainfall.

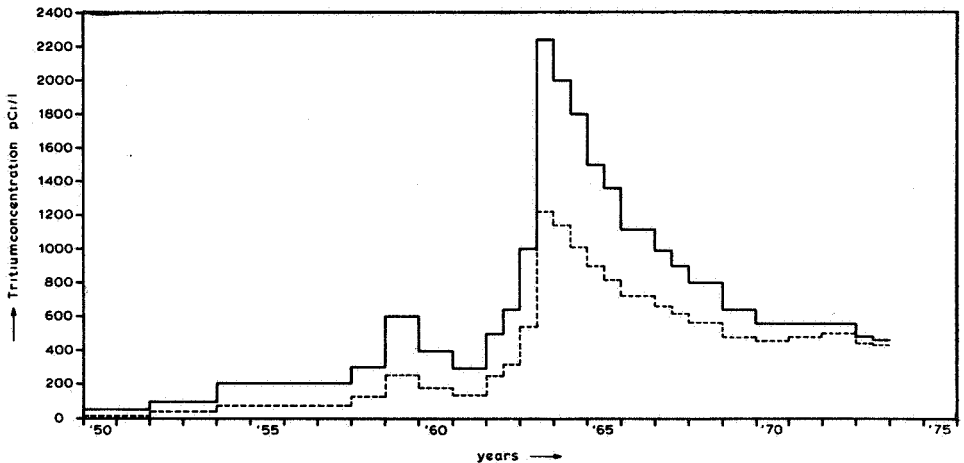

Fig. 6. A provisional estimate of ^3H concentration in water of the Rhine (—) in the course of time and resulting concentrations in 1974 of groundwater derived from the Rhine (---) (partly after WEISS/ROETHER, Der Tritiumabfluss des Rheins, 1961-1973, D. Gew. Mitt. 1975.1).

To interpret values of tritium (^3H) concentrations, figure 6 has been composed (Weiss und Roether, 1975). The following provisional conclusions can be drawn.

a. Tritium concentrations in groundwater discharged by wells 18, 20 and 30 correspond

with values found in 1974 in groundwater recharged by the river Rhine in the period after 1967.

b. Presumably groundwater collected at well 6 was recharged by polder water infiltrated into the underground mainly before 1962 or even before 1958. Note that ^3H concentrations in rainfall will not differ very much from those in Rhine water.

c. Groundwater found at wells 13 and 27 was mainly recharged by water infiltrated before 1962. The percentage of younger water will not exceed 10%.

This example gives lead to the following general conclusion:

Especially observations on natural isotopes of hydrogen and oxygen are very helpful when questions as to origin and retention time of groundwater have to be decided.

TABLE 9
ANALYSES OF GROUNDWATER SAMPLES COLLECTED IN SHALLOW LAYERS IN THE VALLEYS AND IN THE TRANSITION ZONE SURROUNDING THE VELUWE HILLS

NUMBER OF BORING	SCREEN DEPTH (m) SURFACE	DATE OF COLLECTION	Ca ⁺⁺ (mg/l)	Mg ⁺⁺ (mg/l)	Na ⁺ ·K ⁺ (mg/l)	NH ₄ ⁺ (mg/l)	Cl ⁻ (mg/l)	SO ₄ ²⁻ (mg/l)	NO ₃ ⁻ (mg/l)	HCO ₃ ⁻ (mg/l)	CO ₃ ²⁻ (mg/l)	FREE CO ₂ (mg/l)	pH	HARDNESS (mg/l)	Fe (mg/l)	Mn (mg/l)	SiO ₂ (mg/l)	COD (mg/l) KMnO ₄	ELCOND. (μS/cm)
26G-13	22	30-11-62	61	8,4	35,8	0,2	43	49,9	126,4	55	0	30	6,6	3,75	0,08	0,83	16,8	4	483
26G 13	34	30-11-62	53	6	15,5	0,1	25	29,9	0	146	0	18	7,3	3,15	0,10	0,29	8,8	4	344
26G 13	53	30-11-62	62	1,8	18,2	1,1	39	28,2	0	140	0	6	7,8	3,25	1,3	0,33	17,6	9	351
26G 13	75	30-11-62	67	36	27,2	0,40	41	38,1	49,8	122	0	1	8,2	3,65	0,08	0,37	12,8	3	429
32E 64	2-4	1-12-71	107	38,7	33	0,89	45	41	0	471			7,1	8,5	6,8	0,96		118	790
32E 64	10-12	1-12-71	37,8	35	6,5	0,64	7	1	0	137			7,9	2,18	0,60	0,16		6	209
32H 17	20-42	29-7-55	41,8	13,9	39,9	0,06	49	53,1	86	74	0	18,5	7,0	3,3	0,21	0,06	9,6	0,5	424
32H 42	26-63	5-12-55	17,9	4,0	22,9	0,16	36	16,7	20	27	0	6,1		1,2	0,11	0	20,8	2,6	210
33B 42	23-42	22-7-54	36	10,2	55,5	0,8	63	120	0	89	0	7,9		2,7	18,7	1,7	17,6	14	457

9. In some cases changes in groundwater composition could be related to human activities (waste disposal, use of fertilizers and deicing salt), leading to increased concentrations of various dissolved compounds in groundwater. Especially in the Veluwe area human influence on groundwater quality could be observed at great depths.

The Isle of Dordrecht where part of the shallow aquifer is recharged with polluted Rhine water by a largely artificially induced groundwater flow pattern, forms a special case.

If conditions as to direction and rate of groundwater flow are favourable the influence of human activities can be felt in groundwater of large areas and at great depths.

Finally it can be concluded that:

Investigations concerning groundwater composition should be based upon a sound knowledge of hydrological phenomena (evaporation and groundwater flow patterns).

SUMMARY

Groundwater composition is influenced by a complex of geological, hydrological, microbiological, physical and chemical factors. From an outline of the general principles relevant for the situation in the Netherlands it may be concluded that groundwater quality will for a large part be determined by the situation at or near landsurface of the recharge areas concerned. This leads to a central theme, stating that a good insight in the composition of groundwater of the Netherlands can be obtained by investigating a few representative areas, differing from each other with respect to the quality of the recharge water and to the nature of the topography and topsoil. As such have been chosen the Veluwe area (recharge by rainfall; sand), the Betuwe (recharge by the river Rhine; clay) the Isle of Dordrecht (recharge by Rhine; clay and peat) and parts of the dunes (recharge by coastal rain; sand).

The most important conclusions are:

1. In all areas investigated at least one but mostly several components of recharge water quality could be traced back in the groundwater composition.
2. If evaporation occurs prior to infiltration towards groundwater, all concentrations in the recharge water should be multiplied by a condensation factor to give the resulting composition of the groundwater.
3. The denser the vegetation is in the recharge areas and the more organic material is present in the subsoil, the higher concentrations of Ca^{++} , HCO_3^- , NH_4^+ and iron will be found in the groundwater concerned.
4. Once the groundwater has passed the shallow or/and covering layers and flows through sandy aquifers of terrestrial sediments not many changes in composition are to be expected anymore.

LITERATURE

- BAARS, J.K. (1930) – Over sulfaatreductie door bacteriën, Thesis, Delft.
- BARKER, H.A. (1956) – Bacterial Fermentations, Ciba Lectures in Microbial Biochemistry, John Wiley, New York.
- BREEUWER, J.B. and S. JELGERSMA (1973) – An East-West Geohydrological Section Across the Netherlands, Verh. K.N.G.M.G., Vol. 29.
- CONRADS, L.A. en B. BUYSMAN (1973) – Chemie van regenwater, de invloed van stad en industrie, K.R.P. rapport 34, R.U. Utrecht.
- DROST, W. et al. (1972) – Isotopenmethoden in der Grundwasserkunde, Büro Isotop, Brussels.
- DUIJVENBOODEN, W. VAN (1974) – De geohydrochemie van het Jong-Pleistoceen in Salland in relatie tot topografie en geohydrologie, R.I.D. med. 74-8.
- GEIRNAERT, W. (1973) – The Hydrology and Hydrochemistry of the Lower Rhine Fluvial Plain, Thesis, Leiden.
- HEM, J.D. (1970) – Study and Interpretation of Chemical Characteristics of Natural Water, U.S.G.S. Water Supply Paper 1473, Washington D.C.
- INTERNATIONAL ATOMIC ENERGY AGENCY (1968) – Guidebook on Nuclear Techniques in Hydrology, Techn. Report series 91, Vienna.

- LEEFLANG, K.W.H. (1938) – De chemische samenstelling van de neerslag in Nederland, Chemisch Weekblad 35, 658-664.
- MEINARDI, C.R. (1975) – Brackish Groundwater Bodies as a Result of Geological History and Hydrological Conditions, R.I.D. med. 75-1.
- MINDERMAN, G. and K.W.H. LEEFLANG (1968) – The Amount of Drainage Water and Solutes from Lysimeters. Med. 86 of Institute for biological field research, Arnhem.
- MOLT, E.L. (1961) – Verontreiniging van het Rijnwater, Dertiende vakantiecursus in drinkwatervoorziening, Den Haag.
- MOOK, W. (1970) – Stable Carbon and Oxygen Isotopes of Natural Waters in the Netherlands, I.A.E.A., Vienna.
- OVERZEE, B. (1972) – Geo-electrisch onderzoek van het Eiland van Dordrecht en de Merwelanden, Rapport 1950, Rijks Geologische Dienst (unpublished).
- PANNEKOEK, A.J. et al. (1956) – Geological History of the Netherlands, Gov. Pr. and Publ. Office, The Hague.
- PANNEKOEK VAN RHEDEN, J.J. (1942) – Over de reconstructie van voormalige rivierlopen, Tijdschrift K.N.A.G., deel LIX pp 661, 849.
- RIJKSINSTITUUT VOOR DRINKWATERVOORZIENING (1970) – Nota betreffende de waterbalans van een ruimte in het noordwestelijk deel van de Veluwe (unpublished).
- ROMIJN, E. (1974) – Geohydrologische inventarisatie Veluwe, R.I.D.-rapport 74-1.
- SCHOELER, H. (1962) – Les eaux souterraines, Masson et Cie, Paris.
- SCHOLTE UBING, D.W. (1972) – Kwaliteit van oppervlaktewater in Nederland, Werkrapport A68 I.G.-T.N.O.
- STIBOKA (1965) – De bodem van Nederland.
- STOL, Ph. and B. VRIJHOF (1958) – De landbouwwaterhuishouding in de provincie Zuid-Holland.
- TREUIL, M. (1970) – Les diagrammes d'équilibre en hydrochimie, Bull. du B.R.G.M. (2), III.
- VOLKER, A. (1961) – Source of Brackish Groundwater in the Pleistocene Formations Beneath the Dutch Polderland, Economic Geology, Vol. 56.
- WEISS, W. and W. ROETHER (1975) – Der Tritiumabfluss des Rheins (1961-1973), Deutsche Gewässerkundliche Mitteilungen, Jahrg. 19, Heft 1.

INTERACTION-MECHANISMS IN SOIL AS RELATED TO SOIL POLLUTION AND GROUNDWATER QUALITY

F. A. M. DE HAAN*

1. INTRODUCTION

Soil usually consists of three different phases namely a solid, a liquid and a vapour phase. These phases normally occur simultaneously and are in continuous mutual interactions. This is true both when they move and when they are in spatial equilibrium with respect to each other. Real equilibrium conditions are met very rarely only in the dynamic system of soils. Each of the phases mentioned may vary considerably in composition.

Thus the solid phase, which has a spatial build-up giving rise to a porous system, mainly comprises mixtures of quartz sand, organic matter and clay minerals with a vast variety of mixing ratios of these main constituents. In many cases the both last mentioned components constitute a minor weight fraction only of the total solid phase. They play nevertheless a predominant role in the interactions under consideration here. This must be ascribed to their large specific surface area, which causes an extended contact area between these solids and the other phases. Moreover they have a relatively reactive nature as compared to the almost inert quartz sand, and thus may considerably influence the surrounding or adjacent phases. One of the most striking properties in this respect is their ability to adsorb other compounds, especially ions and charged complexes.

The vapour phase, commonly indicated as soil air, shows in the very upper few millimeters of the top layer only the same composition as has the overlying atmosphere. In soils many processes occur, of pure chemical but especially of biological nature, which cause a continuous change of the vapour composition. Exchange with the atmosphere must be obtained by means of diffusion which is a slow process as compared to mass flow. The fact that gaseous diffusion in the liquid phase proceeds roughly 10^4 times slower as does diffusion in the vapour phase explains the huge influence of soil moisture content on the vapour phase composition. It may be mentioned here that the soil gaseous phase sometimes has a very extra-ordinary and homogeneous composition as may be the case in natural gas resources. Although self-evident it is interesting to note that the occur-

* The author is in charge of the educational and research program on Soil Pollution of the Agricultural State University and connected with the Laboratory of Soils and Fertilizers, 3 De Dreyen, Wageningen. He is also guest coworker of the Institute for Land and Water Management Research, 11 Prinses Marijkeweg, Wageningen, The Netherlands.

rence of this same material at sufficiently safe (but explorable) depth is indicated as a soil treasure, whereas the presence of natural gas in the upper soil layer (as for instance caused by leakages in the gas distribution system) may induce considerable damage to vegetation and eventually lead to a situation of soil pollution (Hoeks, 1972).

The liquid phase is usually indicated as groundwater when referring to the zone of complete or permanent water saturation, and as soil solution or soil moisture for that zone where also the vapour phase regularly constitutes an important volume fraction. This phase almost invariably consists of a more or less diluted salt solution. It is for the sake of completeness only that it may be mentioned here that the liquid phase is sometimes composed of other liquids, such as oils. Especially when these occur at the soil surface or low soil depth, as may be the case as a result of for instance oil spills, they must be looked upon as soil and groundwater pollutants. Although quantitatively of minor importance only some consideration is given here to their occurrence in soils as they may cause at extremely low concentrations a complete elimination of water supplies for drinking water purposes.

The salt solution, which mainly constitutes the liquid phase, has a mean salt concentration of roughly 0.01 normal, at least for temperate climatic conditions. Both concentration and ionic composition may vary. The concentration is influenced by natural (or artificial) actions of precipitation and evaporation, whereas the composition depends, amongst other factors, on the type of solid phases but also on human activities.

Because the soil solution provides the medium for uptake of nutrient elements by plant roots, agricultural measures related to fertilization have always been directed towards an increase of the available nutrient elements in solution. The capacity of the solid phase for ion adsorption serves in this respect as a useful tool, thus allowing the farmer to limit his fertilizer applications to one or a very restricted number of fertilizer additions per year. The adsorption complex then acts as a storage reservoir which supplies the solution with new nutrient ions after a decrease of the concentration as a result of plant uptake. This feature, combined with the influence of the ionic composition of the adsorption complex on the physical properties of soil has caused in the past a main interest of soil chemistry in ion exchange phenomena. As will be discussed later a number of other processes are also of importance with respect to the interaction between solid and liquid phase. As such the precipitation of insoluble salts and the dissolution of such salts following changes in physical or chemical conditions of the system must be mentioned.

Soil moisture also serves for evapotranspiration purposes. The moisture which is not evaporated will pass the porous soil system, especially following new supply as a result of precipitation, and will eventually contribute to the groundwater or surface waters.

The increasing demand for high quality water has increased the interest in those factors which influence the water composition. With respect to groundwater the soil undoubtedly acts as one of the most important factors in regulating the water quality.

In addition, an increasing interest may be observed in the possibilities for water renovation by using the soil system. This is so with respect to land disposal of waste water but also with respect to infiltration of soil with water, which as such is of insufficient quality for drinking water purposes. In the latter case the purifying actions of the soil filter result in a quality which meets drinking water standards.

In this contribution the attention is mainly confined to the prime interactions between the solid and the liquid phases in the system soil-water, and to the factors which govern these interactions. Prior to an individual discussion of such mechanisms, a description of the general framework of transport and accumulation of compounds in soil seems to be warranted.

2. ACCUMULATION AND LIQUID PHASE TRANSPORT OF COMPOUNDS IN SOIL

Soil pollution studies mainly concern the transport and accumulation, either on short or on long term, of compounds which may lead to undesirable consequences with respect to groundwater or surface water quality, and with respect to plant composition. Consequences of undesirable composition of the other two main environmental components: air and water, are much more evident than the consequences of undesirable soil composition, because the former are directly perceptible. Soil only serves as an intermediate in the composition of plants and water.

The mobility of different compounds in soil may vary considerably. Some are strongly bound at the solid phase, whereas others are not adsorbed and in some cases even excluded by the solids. The adsorption of cations, for instance, is related to their valency: Ca ions will be better adsorbed than Na ions when both are present at comparable concentration in the soil solution. As a result, the solid phase will preferentially remove Ca ions as compared to Na ions when a solution containing both ions passes the soil. Thus during transport in soils the same mechanism of compound separation prevails as is purposely applied in chromatography. This makes it evident that the mathematical descriptions of transport and accumulation processes in soil are based on the theory of chromatography.

The two main processes responsible for the translocation of compounds in the liquid phase are diffusion and convection. Diffusive transport occurs as a result of a concentration gradient and may contribute in stationary as well as in moving soil moisture. In diffusion the liquid phase only serves as the medium in which the transport process proceeds. Convective transport concerns the translocation of compounds due to the fact that the liquid phase as such is moving. In this case the soil moisture serves as a carrier.

The mathematical descriptions of transport in soil usually take the conservation equation as a point of departure. This equation, as applied to a soil column or part of it, reads: the change of the total amount of a certain compound i , A_i , as a function of time equals the difference of the fluxes, F_i , of this compound through the boundary planes during the time period under consideration:

$$\frac{\delta A_i}{\delta t} = -\nabla \cdot F_i \quad (1)$$

Equation (1), representing the conservation equation in its most basic form, may be extended after substituting the flux term by mathematical descriptions for both transport mechanisms mentioned above. Also the quantity A_i may be subjected to further elaboration. Analytical solutions of the resulting equation can be found only after the introduction of specific simplifying assumptions. If such assumptions are not made, numerical solutions may be arrived at with the use of an electronic computer.

A quantitative treatment of the above, applied to the cationic exchange Na-Ca, has been presented by Reiniger (1970) and Reiniger and Bolt (1972). The elaboration of equation (1) will be confined here to a qualitative approach, since such an approach suffices to demonstrate which interaction mechanisms are of prime consideration with respect to transport and accumulation of compounds in soil. Thus no attention will be given here to some specific problems related to liquid phase displacement, such as dispersion. This is not an oversight but simply a consequence of the limited scope of this contribution. It is pointed out only that dispersion refers to the phenomenon of a spreading of a polluting zone as a result of differences in flow velocities of the liquid phase at different places in the porous system.

The factor A_i , referring to the amount present in the system under consideration, may reflect the total amount of i regardless the form or phase in which i occurs. Usually, however, A_i is limited to the sum of the amount present in solution and of the amount adsorbed at the adsorption complex. Considering ions these quantities may be described with $\epsilon \cdot C_i$ and q_i , respectively, in which ϵ stands for the moisture content in cm^3 per cm^3 of soil, C_i for the concentration of i in solution in meq per cm^3 , and q_i for the amount adsorbed in meq per cm^3 of soil. Thus equation (1) may be substituted by:

$$\frac{\delta (q_i + \epsilon \cdot C_i)}{\delta t} = -\nabla \cdot F_i \quad (2)$$

As mentioned before, other processes than adsorption on the solid phase may also exert an influence on the concentration in solution. This holds for the very common cations like Ca, but also for the less common cations which may be of special interest with respect to pollution problems, like heavy metals, as well as for certain anions. For each of these compounds the concentration in solution may be influenced by the presence of solid phases in the form of insoluble or poorly soluble salts like: for calcium CaCO_3 and CaSO_4 , for lead and zinc PbCO_3 and ZnCO_3 , for phosphate AlPO_4 and FePO_4 . If A_i is defined as above, the presence of such salts and the reactions of precipitation and dissolution have not yet been taken into account by equation (2). This can be done by the introduction of a so-called "production-term".

Such a production term should not necessarily be restricted to merely chemical reactions, but may also account for processes of biological nature as related to mobilization or immobilization of compounds. Such processes are of special interest with respect to the biodegradation of organic compounds, for instance organic chemicals like pesticides. Thus the production term should be divided into a chemical and a biological component. It will be clear that the net result of "production" may be positive or negative depending on the absolute contribution of the process. Biodegradation of a certain compound will thus be reflected in a negative value of the production term.

Introducing this into equation (2) one finally arrives at:

$$\frac{\delta (q_i + \epsilon \cdot C_i)}{\delta t} = \nabla \cdot F_i + P_c + P_b \quad (3)$$

in which P_c and P_b represent the chemical and the biological production rate, respectively. Equation (3) represents a conservation equation of general validity, in which the three main groups of interaction mechanisms are taken into account, namely:

1. adsorption on the exchange complex of soil colloids;
2. chemical reactions of precipitation and dissolution;
3. conversion and decomposition processes of biological nature.

3. ADSORPTION ON SOIL COLLOIDS

The adsorptive bonding on soil colloids is characterized by a high degree of reversibility: adsorbed compounds may relatively easily be exchanged by others. The composition of the adsorption complex depends upon the relative concentrations in solution and on the relative affinity for the solid phase. The electrostatic bonding of cations on clay minerals and soil organic matter represents an example of such reversible adsorption. In case of chemisorption the adsorption is more specific whereas the adsorption forces are much stronger. This characterizes chemisorption by a low degree of reversibility: exchange is restricted to compounds of comparable structure, having comparably high affinity for the adsorber. The bonding of phosphate ions at the edges of clay minerals may be mentioned as an example of chemisorption (De Haan, 1965).

Sorptive bonding on the soil solid phase may be caused by a number of different types of interactions:

1. Coulombic attraction as a result of opposite electric charges of adsorber and adsorbent;
2. other forms of physical bonding, due to London-van der Waals forces;
3. H-bonding, in which hydrogen atoms serve as a bridge between the adsorbent and a reactive group (e.g. carboxylic group or phenolic OH group) of organic matter;
4. metal-ion bonding; in this case a metal ion serves as a bridge between adsorber and adsorbent, sharing bonds with both.

The adsorption of organic chemicals on soil constituents is almost invariably estab-

lished by a combination of two or more of the above bonding mechanisms. So, as an example, the group of herbicides indicated as symmetric triazines can be bound by means of an H-bridge between soil compound and triazine molecule. This may be represented schematically as:

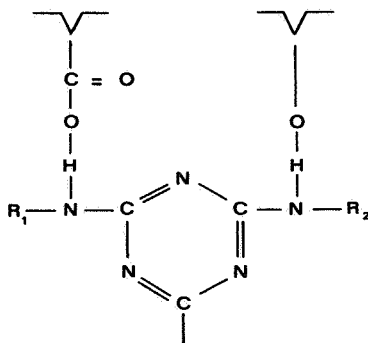

Depending on the pH of the system, the triazine molecule may also be subjected to proton association. In that case the molecule is converted into a divalent cation which may be electrostatically absorbed on organic matter and clay minerals. A schematic representation of this mechanism may be given as:

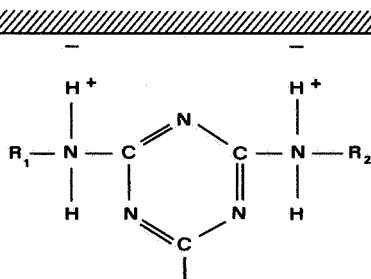

This example clearly demonstrates the predominant role of the pH with respect to such interactions: the value of the pH on the one side determines the proton association and consequently the cation character of the adsorbent, and on the other side the charge of the adsorber especially in the case of organic matter and reactive groups of amphoteric nature.

The discussion is further limited here to the relative simple interaction mechanism listed as 1: the electrostatic bonding between ions and electrically charged soil constituents.

As a result of the predominant negative electric charge of many soil colloids, positive adsorption of cations is one of the most striking features in soil. For the same reason

anions are repelled, i.e. excluded from the charged solid surfaces. In a quantitative sense cation adsorption is by far the most important of both phenomena.

At comparable conditions with respect to the solution concentration and properties of the adsorber the relative adsorption of different cations is strongly influenced by the valency and the size of the (hydrated) ion. For equilibrium conditions the relationship between the cationic composition of the adsorption complex and the concentrations in solution may be described by semi-empirical exchange equations of the type:

$$\frac{\dot{\gamma}_1}{\dot{\gamma}_2} = K \frac{C_{01}}{C_{02}} \quad (4)$$

Equation (4) is indicated as the Kerr equation, applied to the homovalent exchange between homovalent cations; $\dot{\gamma}_1$ and $\dot{\gamma}_2$ refer to the amounts at the adsorber of ions 1 and 2, respectively, whereas C_{01} and C_{02} stand for the concentrations in the equilibrium solution.

The corresponding equation for the hetero-valent exchange of mono- and divalent cations reads as follows:

$$\frac{\dot{\gamma}(\text{mono})}{\dot{\gamma}(\text{di})} = K_G \frac{C_0^+}{\sqrt{C_0^{2+}}} \quad (5)$$

in which C_0^+ and C_0^{2+} represent the molar concentrations of the mono- and divalent cation, respectively. In this equation the influence of ion valency on the adsorption is reflected in the so-called reduced ion concentration ratio, in which each concentration is raised to the power equal to the reciprocal value of the ion valency.

The proportionality factor, K_G , in equation (5) is indicated as the Gapon constant. In practice this is usually not a real constant. For many exchange processes, however, K_G has a very similar value over the exchange range of interest.

For the important Na-Ca exchange K_G has a value of roughly $\frac{1}{2} (\text{mol/l})^{\frac{-1}{2}}$ for many soil colloids. Sometimes, however, the adsorber has a very specific affinity for certain ions as may be the case for the adsorption of K ions on clay minerals of the illitic type (Van Schouwenburg en Schuffelen, 1963; Bolt et al., 1963; De Haan et al., 1965). Here the potassium ions adsorbed apparently could be divided into three main categories. The first category refers to the relatively easily exchangeable ions at the planar sides of the clay platelets. A second category represents potassium ions which, although still exchangeable against other cations, showed a very high preference in adsorption against the other cations. These were indicated as edge or edge-interlattice potassium. Finally a third category concerned potassium ions which actually diffused into the clay crystal lattice and were not exchangeable against other cations. When using the exchange equations as given above, the value of K_G is found as sharply increasing in the order of the three categories of "adsorbed" potassium mentioned.

When the highly preferential adsorption constitutes a minor fraction only of the total

amount of the ion adsorbed, the phenomenon of low exchangeability of part of the ions can be detected only if the exchange process is studied at low degree of saturation with that specific ion. Applying this to the adsorptive behavior of heavy metal ions in soil it must be pointed out that exchange studies of common ions like Na^+ and Ca^{2+} against heavy metal ions like Cd^{2+} , Cu^{2+} , Pb^{2+} or Zn^{2+} over the range of 0-100% saturation of the adsorber with heavy metals are of limited value with respect to the practical applicability of the results. Usually the heavy metals prevail at low concentrations where the exchangeability, due to the presence of specific adsorption sites, may be considerably less than at higher degrees of saturation. The exchangeability, of course, has direct consequences for the mobility of the ion in the soil system.

A graphical representation of ion exchange may be arrived at by means of so-called normalized exchange isotherms. Then the fractional composition of the adsorber with a certain ion, \bar{X}_i is given as a function of the fractional concentration of that ion in solution, X_i . A number of different forms of the normalized exchange isotherm is presented in figure 1.

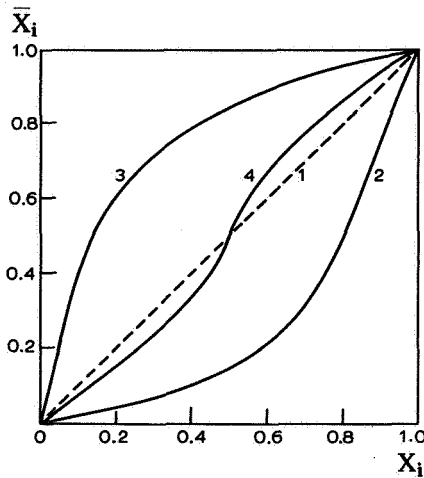

Fig. 1. Several different forms of normalized exchange isotherms.

Line number 1 refers to the situation where no preference of the adsorber for the exchanging ions exists. Line 2 represents an unfavourable exchange, i.e. the adsorption at the complex stays relatively behind at an increase of the relative concentration in solution. In a comparable manner, line 3 refers to favourable exchange indicating a preference of the ion under consideration as compared to the other ion. When applied to homovalent exchange of ion 2 by 1 according to equation (4), (either for monovalent against monovalent ions or divalent against divalent ions), line 1 thus refers to $K = 1$, line 2 to K values < 1 and line 3 to K values > 1 .

Heterovalent exchange may also be represented in this way. In that case line 1 refers

to the exchange of e.g. Ca by Na, line 3 to the exchange of Na by Ca. As may be calculated with the use of equation (5) these lines for heterovalent exchange are shifting towards the corners of figure 1 for decreasing values of the total electrolyte concentration.

Line 4 of figure 1 represents the transition of unfavourable into favourable exchange as reported by El-Sayed et al. (1970) for the exchange of Ca by Cu on montmorillonite. The preference for Cu with increasing adsorption was in this case ascribed to a condensation of clay platelets. As a result of differences in basal spacing the Cu saturated clay is better accessible for Cu ions than for Ca ions.

As mentioned before the exchange studies on heavy metals should be given special attention at low adsorption and low relative concentration values, for instance preferably over the range 0-0.05 in figure 1.

The exchange isotherms may be used for the description of the relationship between the amounts in solution and the amounts adsorbed, in the mathematical solution of equation (3).

The influence of ion adsorption on the distribution of a certain ion i over the solid and liquid phases may be represented by a distribution ratio, R_d . Using the same symbols as before this distribution ratio is given as:

$$R_d = \frac{q_i}{\epsilon \cdot C_i} \quad (6)$$

The reducing effect of adsorption on the movement of a pollutant as compared to the movement of the carrier solution than finally is reflected in:

$$X_p = \frac{V}{R_d + 1} \quad (7)$$

in which X_p represents the mean depth of penetration of the pollutant in the soil, in cm, and V the depth of penetration of the carrier solution, in cm. Equation (7) forms a very useful tool in providing a first estimate of the penetration depth of a compound in soil under a number of simplifying conditions, a.o. that ion exchange is the only or predominant type of interaction between liquid and solid phases and that the zone of penetration is moving as a block front.

4. PRECIPITATION AND DISSOLUTION REACTIONS

Many ions of interest with respect to soil pollution and groundwater quality may occur in the solid phase of soils in a form different from the adsorbed state. When such forms are constituted by solid salts, the activity of the ion in solution is governed by those factors influencing the solubility of the salt. This will be discussed in this section for the, arbitrarily chosen, situation with respect to Fe solubility in soils as described by Novo-

zamsky et al. (1976). This approach may equally be applied to other ions of interest, e.g. phosphate or specific heavy metal ions.

Assuming that the Fe^{3+} concentration in solution is governed by the solid phase indicated as ferrihydroxide, $\text{Fe}(\text{OH})_3(\text{s})$, the equilibrium between solid phase and solution is given by the reaction:

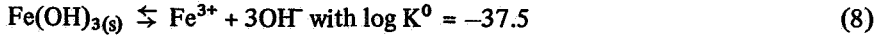

Combination of equation (8) with the dissociation reaction of water according to:

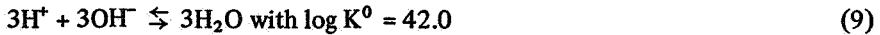

leads to the equation:

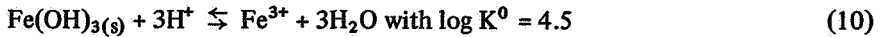

Thus the relationship between the activity of ferric ions in solution and the pH, in the presence of $\text{Fe}(\text{OH})_3$ as the governing solid phase, is found as:

$$-\log(\text{Fe}^{3+}) = -4.5 + 3 \text{ pH} \quad (11)$$

Introducing pa_i as the negative logarithm of the activity of species i , the values of pa for

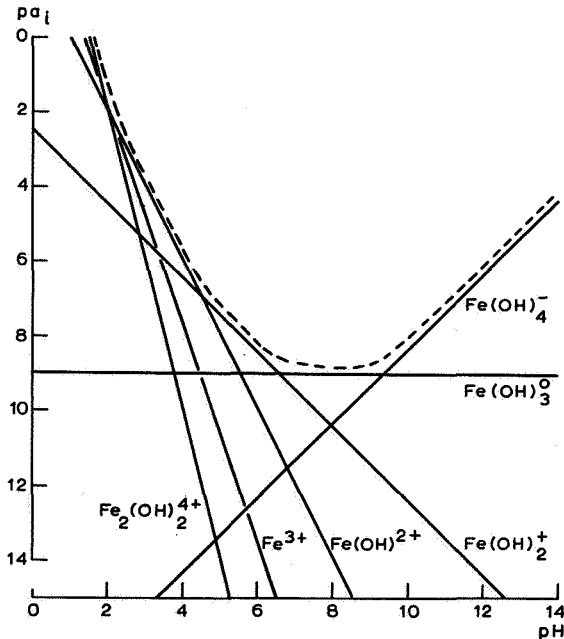
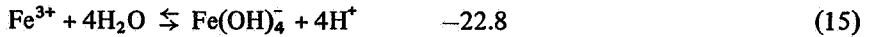
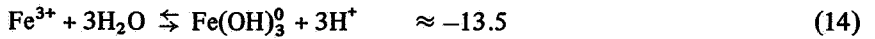
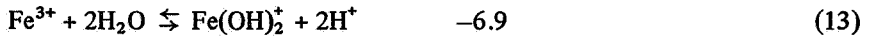
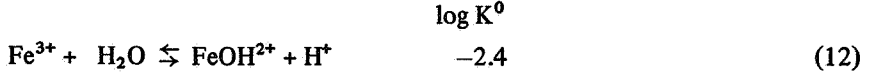

Fig. 2. Solubility diagram of Fe^{3+} in aqueous solution in the presence of $\text{Fe}(\text{OH})_3(\text{s})$ as controlling solid phase.

Fe^{3+} ions may be plotted as a function of the pH of the system according to equation (11). This has been done in the solubility diagram as presented in figure 2.

When measuring the iron activity in solution as a function of pH, the experimental data will deviate from the above line due to the fact that the total iron in solution is not only constituted by ferric ions but also by a number of complexes between ferric ions and water. The formation of 5 of such complexes, which are known to occur, may be represented by the following reaction equations (together with the logarithm of the formation constants):



Each of the above 5 equations may be combined with equation (10), which describes the Fe^{3+} activity as a function of pH in the presence of $\text{Fe}(\text{OH})_{3(s)}$. If this, just as an example, be done for the complex $\text{Fe}(\text{OH})_2^+$ one finds:

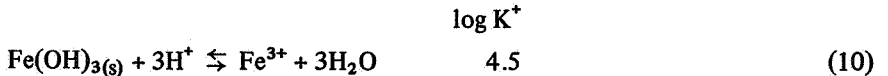

resulting in:



Because $\text{Fe}(\text{OH})_{3(s)}$ and H_2O are pure compounds of which the activity equals unity, equation (17) may be rewritten as:

$$(\text{Fe}(\text{OH})_2^+) = 10^{-2.4} \cdot (\text{H}^+) \quad (18)$$

or:

$$-\log(\text{Fe}(\text{OH})_2^+) = p_{\text{Fe}(\text{OH})_2^+} + 2.4 + \text{pH} \quad (19)$$

Thus equation (19) presents the relationship between the activity of $\text{Fe}(\text{OH})_2^+$ as a function of pH in an aqueous system containing $\text{Fe}(\text{OH})_{3(s)}$. This relationship has been presented graphically in figure 2, together with the solubility lines for the other complexes mentioned above.

The total iron activity in the solution under consideration is found by a summation of the individual species activities, resulting in the broken line of figure 2. As is shown in this figure the activity of the uncharged complex $\text{Fe}(\text{OH})_3^0$ constitutes an important

fraction of the total activity in the pH range of practical interest for many soils. Unfortunately, the value of the formation constant of this complex is uncertain (cf. equation 14), due to experimental problems in its determination. These uncertainties are predominantly caused by the fact that it is hard to distinguish between the uncharged complex in solution and suspended solid phase particles of $\text{Fe}(\text{OH})_3(\text{s})$.

A comparable approach as the above may be applied with respect to heavy metal ion concentrations, which must be expected in soils when low soluble salts of these metals are present, again as a function of varying governing factors. In these cases it is sometimes uncertain which specific solid phase is involved. Lindsay (1972) proposed to summarize the chemical reactions of several heavy metals with soil constituents collectively by fictitious reactions of general form. Then the governing solid phases are indicated as e.g. Cu-soil and Zn-soil when considering Cu and Zn interactions, respectively. Although such an approach may be helpful in the derivation of stability diagrams of heavy metal compounds in soil, it is subject to a couple of limitations. Firstly the collective description of reactions is masking the actual processes which may be involved, thus making a distinction between possible different reactions impossible. Moreover, the stability considerations are usually extrapolated to the entire pH range of 0-14, whereas the formation constant of the metal-soil complex is measured over a very limited pH range only. The validity of such extrapolation is highly uncertain.

The above considerations all pertain to equilibrium conditions. If such conditions prevail, derivations and calculations related to chemical equilibria are indispensable in the prediction of expectable concentrations and of the relative stability of different compounds in soil.

Actually, however, one is interested in the kinetics of chemical reactions in order to evaluate rates of different processes involved. Until recently these kinetics have received minor attention only with respect to chemical reactions in soil. A quantitative evaluation of the contribution of P_c of equation (3), e.g. with respect to the phosphate concentration in solution when solid phosphate phases are present, requires quantitative information about the kinetics of precipitation and dissolution reactions of phosphate salts known to occur in soil. The most important solids in this respect are variscite, $\text{AlPO}_4 \cdot 2\text{H}_2\text{O}(\text{s})$, strengite, $\text{FePO}_4 \cdot 2\text{H}_2\text{O}(\text{s})$, and hydroxyapatite, $\text{Ca}_{10}(\text{PO}_4)_6(\text{OH})_2(\text{s})$.

The interpretation of experimental results of such kinetic studies is not always unambiguous and may become fairly complicated by the fact that it is difficult to decide which part of the disappearance of e.g. phosphate ions from solution into the solid state must be ascribed to adsorption on colloidal soil constituents and which part to the formation of new solid phases in the form of precipitates. Chen et al. (1973) interpreted their phosphate interaction data with aluminum oxide and with kaolinite as a combination of both processes. They concluded to the existence of a rapid adsorption on easily accessible adsorption sites and of a slow process of phosphate disappearance from the liquid

phase due to the formation of AlPO_4 . This last process apparently obeyed a first-order rate law; the rate constant could be derived from the experimental data.

In view of further development of our knowledge about the chemical behavior of compounds in soil, studies on the kinetics of the chemical reactions involved deserve high priority.

5. BIOLOGICAL DECOMPOSITION PROCESSES

Many compounds, when present in soil, are subject to conversion reactions of biological and especially microbiological nature. This is so for specific materials like organic chemicals, but also for the ordinary organic matter which is added to the soil e.g. as manure or falling foliage. Conversion of such fresh organic matter into more stable compounds is strongly enhanced by the activity of aerobic heterotrophic microorganisms. At sufficient oxygen supply these reactions terminate in the production of CO_2 and H_2O , whereas the increase of "stable" organic matter in the soil results from a.o. dying and decomposing microbial cell material.

In the case of pesticides these biological conversion reactions may constitute the main processes for disappearance of the compounds from the soil system. It is thus evident that especially in this field of interest attention has been given to decomposition reactions because they usually are the main factor governing the persistence of the chemical. Decomposition of a certain compound is reflected in equation (3) by a negative value for P_b .

Hamaker (1972) presented a comprehensive discussion of the mathematics of such biological decomposition processes. Equations describing the reactions may be grouped into two main categories, namely the so-called power rate equations and the hyperbolic rate equations. The first mentioned category may be represented by the general equation:

$$\frac{\delta C_i}{\delta t} = -kC_i^n \quad (20)$$

in which k stands for the rate constant and n for the order of the reaction.

The hyperbolic rate equations are of the type:

$$\frac{\delta C_i}{\delta t} = -\frac{k_1 C_i}{k_2 + C_i} \quad (21)$$

indicating that the rate of decomposition depends upon the concentration and upon the sum of concentration and other factors.

In many cases it is hard to decide from experimental data which of both rate models is best applicable. As described by Leistra (1973) calculations on transport and accumulation of pesticides in soil usually take the simplified power rate model as a point of departure, if at all a biological production factor has to be taken into account. This simpli-

fied model assumes the decomposition to be a first order reaction. In that case the rate simply relates to the concentration which is still present, according to:

$$\frac{\delta C_i}{\delta t} = -kC_i \quad (22)$$

Also the decomposition of oil in soil is a process which is mainly established by specific aerobic microbes. The rate is highly influenced by factors governing the microbial activity such as temperature, oxygen supply and supply with other nutrient elements like e.g. N, P, K and S. Thus the decomposition rate may be increased by measures directed towards an optimalization of microbial growth conditions e.g. fertilizer supply and disking of the oil contaminated soil in order to improve the oxygen supply (De Haan and Zwerman, 1976).

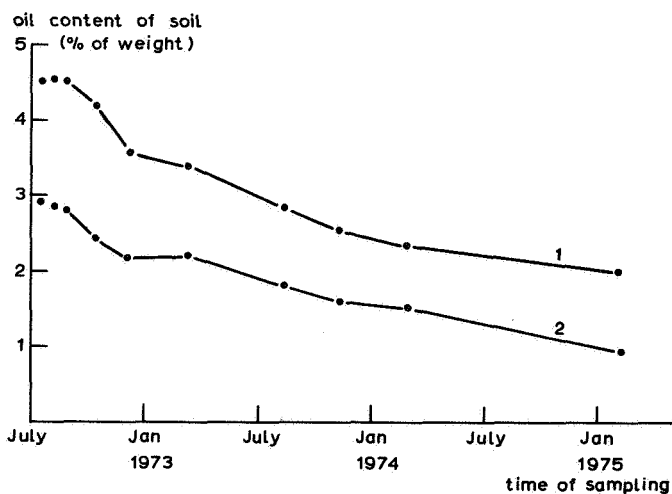

Fig. 3. Decomposition of oil in soil at two levels of oil pollution.

Figure 3 presents experimental data of field measurements on oil decomposition following an oil spill. Two different degrees of oil pollution were involved in these experiments. A gradual, although slow decomposition of the oil is observed in both cases. With respect to this low velocity it must be mentioned that the climatic conditions during the period of investigation have been deviating from mean values, both as regards summer temperatures and precipitation. Comparable experiments at Houston, U.S.A., indicated higher decomposition rates as a result of much more favourable climatic conditions (Kincannon, 1972).

It is realized that the data of figure 3 are far too rough to allow a quantitative interpretation with respect to decomposition reactions involved. In a qualitative sense it may

be observed that the rate is somewhat higher during the summer periods than during the other seasons.

Also in calculations on the distribution pattern of natural gas in soil near gas leaks, CH_4 decomposition as a result of the activity of methane-oxidizing microbes has to be taken into account (Hoeks, 1972). It was found that the metabolic activity of these microbes was influenced by a number of factors of which the most important ones are: supply with methane and oxygen, the carbondioxide level in the gaseous phase, the soil temperature and the fertility status.

One of the main problems in inserting the biological production factor into equation (3) is the limited applicability of laboratory determined decomposition rates to field circumstances. The actual variation of factors which influence the decomposition in practice is usually much larger under field conditions than in the laboratory studies. Moreover, decomposition experiments are commonly conducted at optimal conditions for microbial activity, which conditions are met very rarely only in practice.

6. A PHOSPHATE ACCUMULATION PROFILE AS AN EXAMPLE

This section is devoted to the discussion of an actual distribution profile of phosphate in soil as may be observed in practice. The example presented refers to soil of a sewage farm, on which monthly applications of raw sewage water have been applied during a time period of 50 years. A comparison between the composition of the raw sewage water and drainage water indicates that this land disposal system results in a very effective waste water treatment. Percentages of removal amount to 98% for BOD_5 , 80-85% for nitrogen and 96% for nitrogen and 96% for phosphate.

Figure 4, taken from Beek and De Haan (1973), presents the distribution of phosphate in the flooded soil as a function of depth. Also the phosphate content of the non-flooded forest soils, from which the farm has been reclaimed and which still are surrounding the farm, is presented. It is shown that the distribution pattern can be indicated as a typical accumulation profile, since 90% of total phosphate storage occurs in the upper 40 cm and 65% in the top 20 cm.

In view of the small contact time between sewage water and soil the mechanism of phosphate removal must be an extremely efficient one. This points to adsorption on reactive sites of soil constituents as the most probable type of bonding. However, phosphate adsorption capacities of the adsorbing constituents are too small to account for the total phosphate storage measured. Thus the above authors suggested the alternation of surface adsorption and precipitation during the time period in between two successive waste water applications. The formation of insoluble phosphate phases, e.g. as AlPO_4 or FePO_4 would render new adsorption sites for the effective adsorptive phosphate removal of the next flooding. The phosphate concentration of the drainage water is in agreement

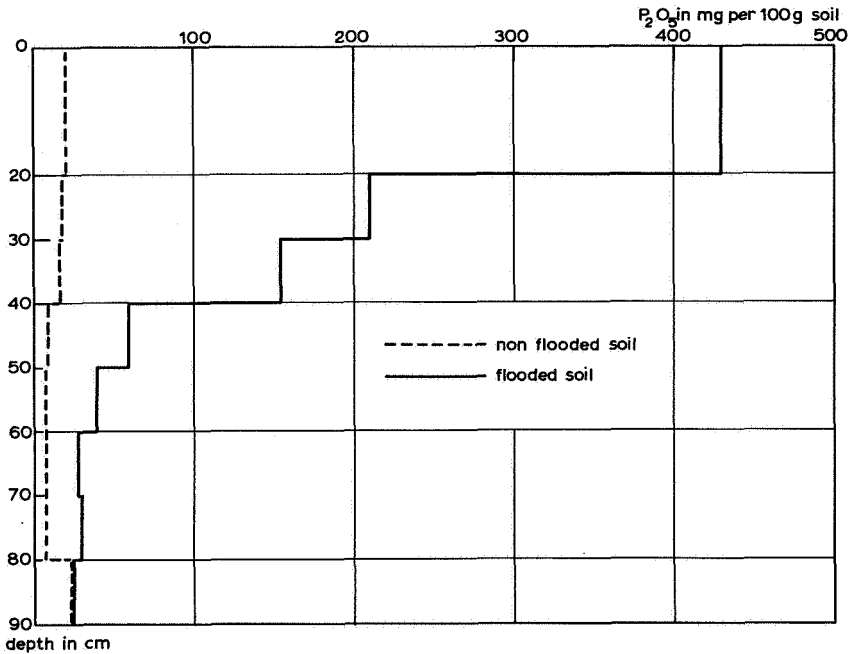

Fig. 4. Phosphate distribution with depth in nonflooded soil and soil flooded with sewage water (after Beek and De Haan, 1973).

with the value to be expected according to chemical equilibria considerations, for the relevant pH level.

This example demonstrates the necessity of a combination and relative evaluation of the different interaction mechanisms as described before. This is true with respect to the explanation of distribution patterns which have been developed in soils, but even more so with respect to the prediction of long-term results relating soil accumulation of specific compounds and a possible break-through of the soil filter.

SUMMARY

After an introductory description of the three soil phases: solids, air and liquid, the main factors which are of interest with respect to transport and accumulation of compounds in soil are discussed. Starting from the conservation equation in its most basic form a qualitative elaboration indicates that the predominant interactions may be listed as: adsorption on soil colloids, precipitation and dissolution reactions, and conversion reactions of biological nature.

Ion adsorption and exchange is described with the help of different normalized ex-

change isotherms. It is reasoned that adsorption of heavy metals may probably deserve special attention over a small exchange range due to the possible occurrence on many colloids of sites with high preference for certain ions.

As an example a solubility diagram is derived, showing the solubility of Fe^{3+} and different complexes of this ion with water as a function of pH, assuming the presence of $\text{Fe}(\text{OH})_3(s)$ as the controlling solid phase. Aside from equilibria considerations the kinetics of chemical reactions in soil deserve more attention. In the development of model calculations on transport and accumulation the rate of these reactions is of prime importance.

This is equally true with respect to the third major mechanism controlling the concentration of compounds in solution: conversion and usually decomposition reactions by microbes. Experimental data are presented on the decomposition of oil in soil following an oil spill.

Finally, the distribution of phosphate is presented in soils, which have been subject to regular flooding with raw sewage water during a time period of 50 years. This example provides a good demonstration of accumulation and of the fact that usually a combination of different interaction mechanisms, either simultaneously or alternatively occurring, must be considered.

LITERATURE

- BEEK, J. and F.A.M. DE HAAN (1973) – Phosphate removal by soil in relation to waste disposal. Proc. Int. Conf. Land for Waste Management, Ottawa, p. 77-86.
- BOLT, G.H., M.E. SUMNER and A. KAMPHORST (1963) – A study of the equilibria between three categories of potassium in an illitic soil; Soil Sci. Soc. Am. Proc. 27, p. 294-299.
- CHEN, Y.S.R., J.N. BUTLER and W. STUMM (1973) – Kinetic study of phosphate reaction with aluminum oxide and kaolinite; Envir. Sci. Technol. 7, p. 327-332.
- EL-SAYED, M.H., R.G. BURAU and K.L. BABCOCK (1970) – Thermodynamics of Copper II – Calcium exchange on bentonite clay; Soil Sci. Soc. Am. Proc. 34, p. 397-400.
- HAAN, F.A.M. DE (1965) – The interaction of certain inorganic anions with clays and soils; Agr. Res. Rep. 655, 167 pp.
- HAAN, F.A.M. DE, G.H. BOLT and B.G.M. PIETERS (1965) – Diffusion of potassium 40 into an illite during prolonged shaking; Soil Sci. Soc. Am. Proc. 29, p. 528-530.
- HAAN, F.A.M. DE and P.J. ZWERMAN (1976) – Pollution of Soil. In: Soil Chemistry; Elsevier Publishing Comp. The Hague, p. 192-271.
- HAMAKER, J.W. (1972) – Decomposition: Quantitative aspects. In: Organic chemicals in the soil environment, Vol. I, New York: Marcel Dekker.
- HOEKS, J. (1972) – Effect of leaking natural gas on soil and vegetation in urban areas; Agr. Res. Rep. 778, 120 pp.
- KINCANNON, C.B. (1972) – Oily waste disposal by soil cultivation process; EPA-R2-72-110, 115 pp.
- LEISTRA, M. (1973) – Computation models for the transport of pesticides in soil; Residu Reviews 49, p. 87-130.
- LINDSAY, W.L. (1972) – Inorganic phase equilibria of micronutrients in soils; In: Micronutrients in Agriculture; Soil Sci. Soc. Am. Inc.

- NOVOZAMSKY, I., J. BEEK and G.H. BOLT (1976) – Chemical equilibria; In: Soil Chemistry: Elsevier Publishing Comp. The Hague, p. 13-42.
- REINIGER, P. (1970) – Movement and exchange of sodium and calcium in calcareous and gypseous soils. Ph.D. Thesis, The Hebrew University, Jerusalem, Israel.
- REINIGER, P. and G.H. BOLT (1972) – Theory of chromatography and its application to cation exchange in soils; Neth.J.Agr.Sci. 20, p. 301-313.

NITROGEN, PHOSPHATE AND BIOCIDES IN GROUNDWATER AS INFLUENCED BY SOIL FACTORS AND AGRICULTURE

J.H.A.M. STEENVOORDEN

Scientist, Institute for Land and Water Management Research, Wageningen, The Netherlands

1. INTRODUCTION

Groundwater pollution can be caused by diffuse sources as agriculture and precipitation, or by point-sources like industrial and domestic sewage, garbage dumps, etc. In rural areas agriculture can be regarded to be the most important potential pollutor with regard to nitrogen, phosphate and biocides because of the intensive use of fertilizers, organic manure and biocides for raising production and protecting the crop.

As these compounds come into contact with the soil, the danger exists that as a result of a precipitation excess transport to deeper soil layers and eventually to ground and surface water will take place. The use of good quality ground and surface water for drinking water supply, nature conservation and agriculture, may be impeded by this process. Therefore limits have been put on the concentration of these compounds in the water to be used. With respect to nature conservation the concentration of inorganic phosphate and inorganic nitrogen should not surmount certain values to prevent eutrophication of surface waters. For drinking water for man and livestock limits have been set for the nitrate concentration. Biocides are undesirable in ground- and surface water because of the toxic influence of many of these compounds on man, livestock, flora and fauna.

Nitrogen, phosphate and biocides are involved in chemical, physico-chemical and biochemical processes in the soil. The extent to which these processes are capable or still are capable in preventing pollution of groundwater by agricultural activities will be illustrated in the next paragraphs.

2. NITROGEN

2.1. *General*

The dissolved nitrogen compounds normally found in groundwater are nitrate, nitrite, ammonium and organic nitrogen. It is of no direct interest to pay attention to each and every of these compounds. The nitrite concentration generally is very low and in the order of some hundredths of milligrams of nitrogen per liter. Nitrite is a very instable compound which is quickly converted into other products. The organic nitrogen content

in groundwater generally is no more than some tenths of milligrams of nitrogen per liter, especially at depths greater than some meters. The most important nitrogen compounds are ammonium and nitrate because their concentration can range from nearly zero to even more than some tens of milligrams of nitrogen per liter.

The sorption by soil particles for ammonium is different from that for nitrate because of their difference in electrical charge: ammonium ions have a positive charge and that of nitrate ions is negative. As the soil mainly consists of negatively charged particles, ammonium will be adsorbed by the soil whereas nitrate will be very mobile.

Nitrogen compounds also take part in biochemical processes. There is a continuous turnover of inorganic compounds into organic compounds and vice versa. In groundwater, where the conditions generally are anaerobic, the turnover rate is much lower than in aerobic soil layers.

2.2. Pollution by agriculture

The potential threat of groundwater contamination by nitrate from agriculture has increased considerably during the last decades by the increase of the nitrogen consumption, especially in the form of fertilizers. In the Netherlands fertilizer consumption did increase between 1955 and 1970 from 71 to 154 kg N per ha per year and the use of manure nearly doubled in the same period from 40 to 71 kg N per ha per year and the use of manure nearly doubled in the same period from 40 to 71 kg N per ha per year (United Nations, 1974). As 60 to 70% of the area in the Netherlands is in use for agriculture, the study of the fate of nitrogen in the topsoil and in the groundwater is of great importance for the control of surface and groundwater quality.

With respect to the contribution of agriculture three relevant questions can be put. The first is: how much nitrogen is on the average leaching to the groundwater; the second: which nitrogen compound is active in the leaching process; the third: which processes are of importance to the leached nitrogen during transport to the deeper groundwater or to surface waters.

Regarding the first question, information can be found in the research work of Kolenbrander (1972). The results are based on lysimeter and drainage field experiments and

Table 1. Nitrogen loss from arable land and grassland on sandy and clayey soils to the groundwater (precipitation 760 mm per year, evapotranspiration 460 mm per year). Farm yard manure 100 kg N/ha and fertilizer as indicated.

	Fertilizer	Sandy soil		Clayey soil	
		kg N/ha	mg N/l	kg N/ha	mg N/l
Arable land	90 kg N/ha	88	25	33	9.5
Grassland	200 kg N/ha	13	3.5	13	3.5

apply to the climatic conditions in the Netherlands with an average precipitation of 760 mm per year and an average evapotranspiration of 460 mm per year. On sandy arable land the nitrogen losses are highest and the concentration in the drainage-water can be some tens of milligrams N per liter (table 1). The losses on grassland are much smaller although the fertilizer level is higher. The leaching on grassland is not influenced by the type of soil. Of course large differences in fertilizer level exist in practice and there are more soil types than sand and clay, but the given data give a good idea of the order of magnitude that is to be expected for the leaching of arable land and grassland and of the influence of soil type. The small losses on grassland are mainly caused by the continued soil cover of growing vegetation, the application of fertilizer and manure in several gifts and the favourable conditions for denitrification in the rooting zone (Huntjes, 1972).

Nitrogen leached in lysimeter and drainage field experiments appears in the form of nitrate. As the nitrate concentration of drainage water from sandy arable land is much higher than the nitrate limit for drinking water the third question is very important: in which processes is nitrate involved during the transport in groundwater. This will be dealt with in the next paragraph.

2.3. Nitrate in the groundwater

Once nitrate has reached the groundwater it will be subjected to groundwater flow either to the deep groundwater or to surface waters. The length of the transport pathway depends on the geohydrological conditions. During transport the nitrate concentration can change as a result of dilution and of biochemical and chemical reactions.

The most interesting process in which nitrate is involved in the groundwater is denitrification, which can proceed via biochemical and chemical reactions:

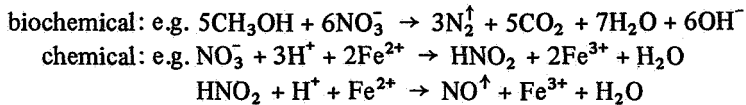

In the biochemical denitrification process bacteria use nitrate as hydrogen acceptor instead of oxygen for the production of energy (Woldendorp, 1963). The nitrate nitrogen is converted to gaseous compounds as N_2 , N_2O or NO , depending on the environmental conditions. Chemical reactions between nitrate or nitrite and soil constituents as ferrous iron (Chao and Kroontje, 1966) and soil organic matter (Stevenson and Swaby, 1964) also can be responsible for denitrification.

Some conditions must be met before denitrification in the groundwater can take place, namely a shortage of oxygen and the presence of an adequate energy source.

It is not necessary that the groundwater is entirely anaerobic, but the oxygen demand must exceed the oxygen availability. The extent to which denitrification can proceed depends on the length of time the mentioned conditions are met. The longer the residence time, the more nitrate can be reduced.

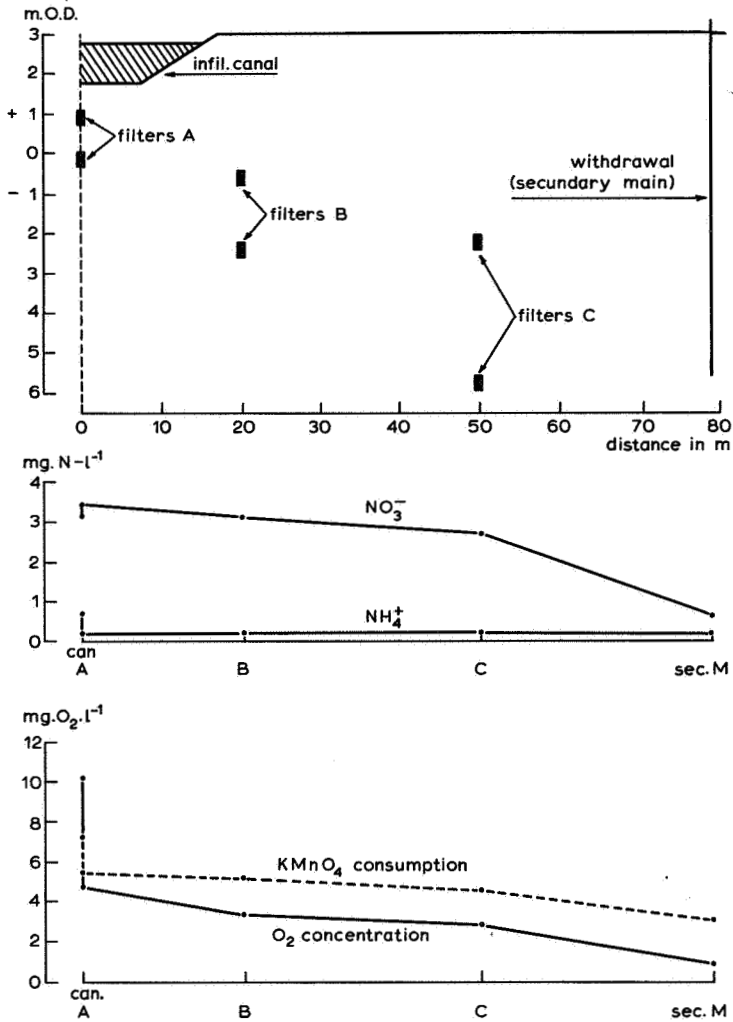

Fig. 1. Cross section of the infiltration field and the averaged results of some analyses of the infiltration water along the transport pathway.

The successive processes occurring during the transport of water in the saturated zone are clearly illustrated by the results of the Water Supply Company P.W.N. with dune-infiltration of river water (Lips, Bulten and Van Puffelen, 1969). The results cover the period from 1959 until 1968. A cross section of part of the infiltration field and the concentration of some compounds along the transport pathway are given in fig. 1. Between the infiltration canal and filters A most of the ammonium is oxidized to nitrate and the

oxygen content drops because of the oxidation of organic matter, ammonium, and other inorganic matter. From filters A to C the nitrate, oxygen and organic matter content show a small but constant decrease. After passing filter C their concentrations drop rapidly. Nearly all nitrate has vanished, probably by denitrification. The drop in nitrate concentration (3.1 mg N/l) seems of little importance as compared to the high nitrate losses in sandy arable land. One should realise, however, that the infiltration rate of river water in the dunes is 35 cm per day with a residence time of 6 weeks. The average infiltration rate of a precipitation excess is only 0.1 cm per day and the residence time in groundwater can range from some hours to some hundreds of years, and long residence times are characteristic for the deep groundwater.

In the groundwater of agricultural land the conditions for denitrification as a rule appear to be favourable. At roughly 2 m below the groundwater table the average oxygen content is only some tenths of mg O₂ per l. The amount of organic matter, measured as KMnO₄-consumption, in the upper 2 m of the groundwater is in the range of 10 to 15 mg O₂ per l for sandy areas and 50 to 150 mg O₂ per l for eutropic peat areas (Oosterom and Steenvoorden, 1974). The residence time in the groundwater therefore will be of great importance for the degree of denitrification.

Nitrate concentrations in the surface water can give some information on processes occurring in the groundwater. Differences in the geohydrological situation near the brooks Leerinkbeek, Oude Leerinkbeek and Deldensche Broeklaak in the East-Gelderland

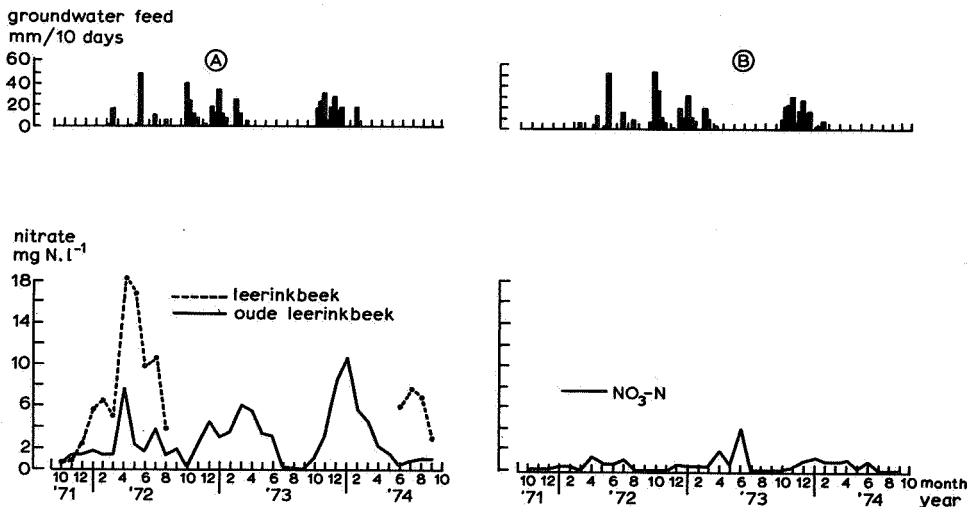

Fig. 2. Calculated net groundwater feed (precipitation - evaporation - storage above groundwater level) and nitrate concentration in the brooks Oude Leerinkbeek and Leerinkbeek (A) and Deldensche Broeklaak (B).

area, cause a significant difference in nitrate path. In the two first named brooks high nitrate concentrations are recorded in periods with groundwater feed, whereas the concentration in the last named brook constantly remains at a low level (fig. 2). The agricultural activities are quite the same in these areas, but from East to West the thickness of the well-permeable sandy layer increases from roughly half a meter in some parts of the Leerinkbeek watershed to more than forty meters in the area of the Deldensche Broeklaak (Ernst, De Ridder and De Vries, 1970). The average residence time can be calculated (Ernst, 1973) to be 45 years for the Deldensche Broeklaak and 10 years for the Oude-Leerinkbeek. The average residence time in the area of the Leerinkbeek even will be shorter as a result of the thin sandy layer and the larger slope of the groundwater table. A longer residence time not only means an increased period of denitrification but also a mixing with groundwater having a different history with regard to fertilization and a different arable land and grassland ratio. To compare the nitrate concentrations in the Leerinkbeek and the Oude Leerinkbeek, the agricultural situation ten to twenty years before sampling is an essential datum. With respect to leaching of nitrate it can be presumed that the decrease of arable land from 36 to 24 per cent of the total agricultural area in the period 1952 to 1970 (Prov. Landbouwkundige Dienst, 1972) is neutralized by the slight increase in fertilization of arable land. Grassland is of little importance in the leaching of nitrate (table 1). The increase in fertilization on arable land does not give an explanation for the large differences in nitrate concentration found in Oude Leerinkbeek and Leerinkbeek. The lower concentrations in the Oude Leerinkbeek mainly will be caused by a longer residence time and a better denitrification. The same will apply to the Deldensche Broeklaak although there is little information about the changes in fertilization and the arable land and grassland ratio since the beginning of this century.

Denitrification does not mean, however, that permanent groundwater pollution with nitrate does not occur. According to 268 groundwater analyses from East-Gelderland 28 samples contained nitrate, with an average concentration of 8 mg N.l^{-1} . The nitrate containing samples were found in towns, near factories and in agricultural areas. It is very likely that lack of an adequate energy source prevented complete denitrification, as is shown by the distribution of organic matter content in samples with and without nitrate (fig. 3). Most of the nitrate containing samples are found in the classes with lowest organic matter content.

2.4. *Ammonium in the groundwater*

Ammonium is strongly adsorbed to soil particles. Therefore the ammonium concentration of the groundwater to a large extent will be influenced by soil composition. In the groundwater of some nature areas the amount of ammonium in the upper meter of groundwater appears to be correlated with the quantity of organic matter in the soil (table 2). The concentration in the oligotrophic highmoor area is higher than in the poor sandy areas, but lower than in the mesotrophic lowmoor area. The differences in con-

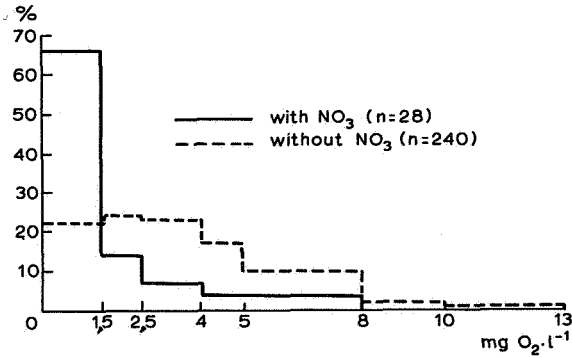

Fig. 3. Distribution (%) of 268 groundwater samples from East-Gelderland over KMnO_4 -consumption classes ($\text{mg O}_2 \cdot \text{l}^{-1}$) indicative of organic matter content.

centration as a result of soil composition can even be more extreme, as is shown by analyses of groundwater from the West-Netherlands and East-Gelderland. East-Gelderland has an area of approximately 100,000 ha and the top fifty meters of the soil mainly

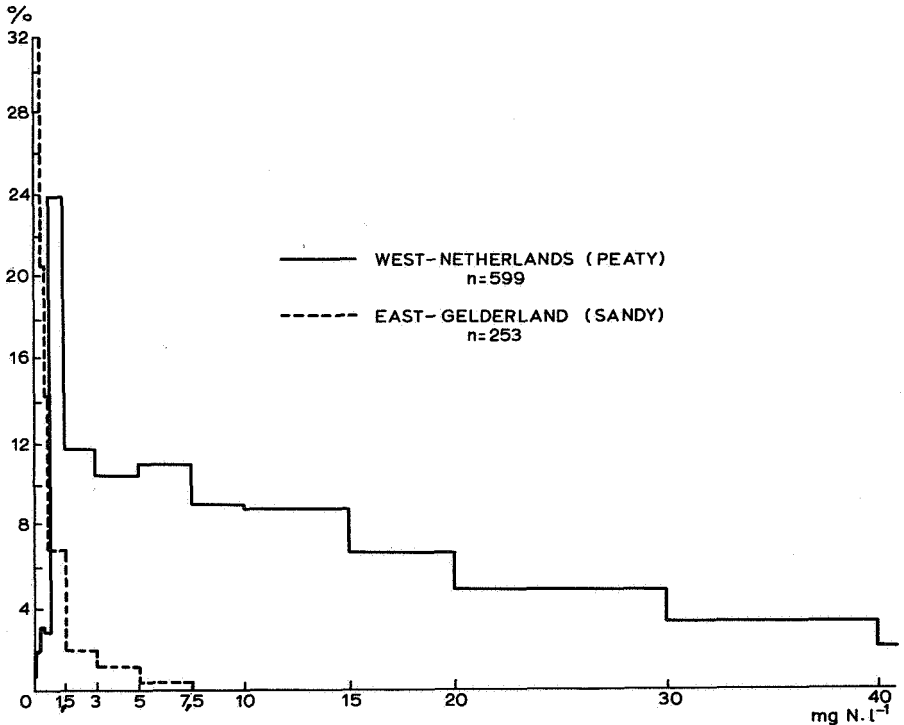

Fig. 4. Distribution (%) of 852 groundwater samples over NH_4 -concentration classes ($\text{mg N} \cdot \text{l}^{-1}$).

Table 2. Nitrogen-concentration (mg N.l^{-1}) in the upper meter of the groundwater of some nature areas in the Netherlands

	Poor sand with conifers	Poor sand with deciduous trees	Highmoor on sand with heather	Mesotrophic lowmoor with grass
NO_3	<0.2	<0.2	0.2	0.4
NO_2	<0.01	<0.01	<0.01	0.01
NH_4	0.5	0.4	0.8	1.9
Organ. N	0.5	0.5	0.5	2.1
Total N	1.0	0.9	1.5	4.4

consist of gravel bearing sands of fluvial and fluvio-glacial origin, and of tertiary clays and clayey fine sands (Ernst, De Ridder and De Vries, 1973). The West-Netherlands has an area of approximately 200,000 ha and the environmental conditions during its formation were heavily eutropic. Especially in the top ten to twenty meters (Van Rees Vellinga, 1972) peat layers can be found. During the geohydrological investigations by the Water Supply Company "Oost-Gelderland" the Netherlands Geological Survey and the Institute for Land and Water Management Research hundreds of analyses have been performed. The distribution of the ammonium concentration significantly differs for East-Gelderland and the West-Netherlands (fig.4). The mean concentration is 0.44 mg N.l^{-1} for East-Gelderland and 8.0 mg N.l^{-1} for the West-Netherlands.

3. PHOSPHATE

3.1. General

The phosphate concentration is built up by inorganic and organic compounds. This difference is based on the chemical reactivity with molybdate (Murphy and Riley, 1962). Another difference is to be made between the dissolved and the insoluble fraction. The dissolved phosphate is the phosphate present in the filtrate of a sample after passing a 0.45 micron filter (FWPCA, 1969). The soluble reactive fraction normally is called ortho-phosphate. Total-phosphate includes the inorganic and organic phosphates.

The mobility of ortho-phosphates in nearly all the soils is very restricted as a result of chemical reactions with clay-minerals and especially certain metal ions. In calcareous soils and in non-calcareous although neutral soils, water-soluble phosphates are precipitated as calcium compounds; in acid soils they are bound to iron and aluminium hydroxides and oxides and to positive charges on colloids in the soil (see e.g. De Haan, 1975). In-

organic and organic phosphates are also involved in bio-chemical processes. There is a continuous turnover from inorganic into organic phosphate and vice versa by bacterial activity and by chemical processes. Some observations on the mobility of organic phosphates in the soil have shown that substantial fractions of the mobile phosphorus in a soil solution consist of dissolved and colloidal organic phosphorous compounds (Stumm and Morgan, 1970).

The solubility of phosphate may increase significantly by a complex formation of phosphate and metal ions (e.g. Fe, Ca, Mg). The extent of complexing will depend upon the relative concentrations of phosphate and metal ions, the pH and the presence of other ligands as SO_4 , CO_3 and organic matter (Stumm and Morgan, 1970; De Haan, 1975).

3.2. Contribution of agriculture

In agriculture P has been added to the soil in the form of manure and fertilizer for many decades. The question arises to what extent the excess is precipitated as insoluble phosphate in the top layers of the soil and to what extent the excess P is transported to the subsoil or the groundwater.

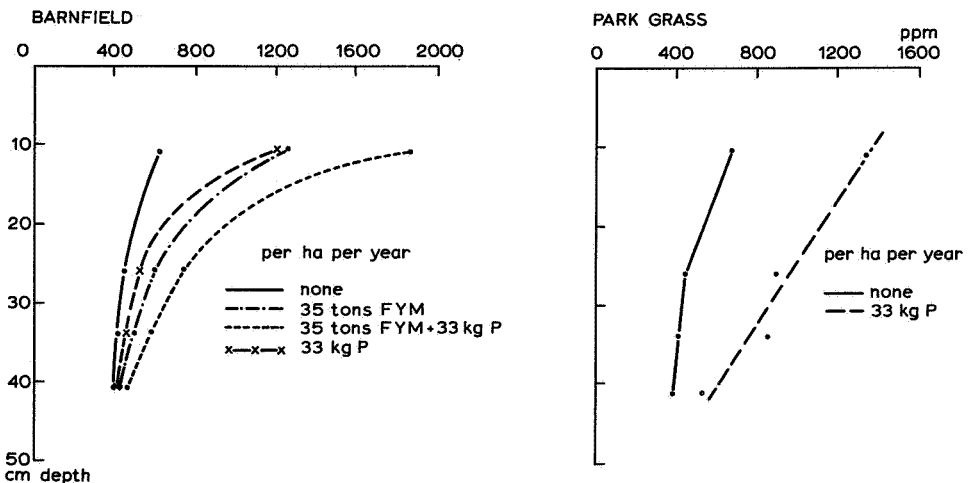

Fig. 5. Total-phosphorus content of soils from the Park Grass and Barnfield experiments (after Cooke and Williams, 1970).

In England some experiments with P-applications have been carried out for over a century (fig. 5). The soil was non-calcareous and loamy. The Barnfield experiment concerns food crops. The P was applied annually as superphosphate (33 kg P/ha) respectively farmyard-manure (35 tons/ha) or both materials together. In the Parkgrass experiment the P application was 33 kg P as superphosphate. Some of the supplied P

penetrated 38 cm or more (fig. 5), but the P soluble in 0.01 M calcium chloride is no more than in the corresponding subsoil of the non-fertilized plot (Cooke and Williams, 1970). The same has been found in lysimeter experiments in the Netherlands. In a silty-loam arable land lysimeter, which annually was supplied with 25 kg P.ha⁻¹, the phosphate had been transported in forty years to 5 cm below the furrow. The transport in a sandy grassland lysimeter, annually supplied with 74 kg P fertilizer per ha was restricted to the top ten cm after ten years (Kolenbrander, 1972).

The transport of inorganic phosphate is relatively quick in soils rich in organic matter, like plagget soils and newly reclaimed peat soils on sand, as was shown in pot experiments by De Vries and Van der Pauw (1937). Other experiments also indicate that fertilizer phosphate enters the subsoil only from soils rich in organic matter, either because farm-yard manure was applied each year or because they are permanent pasture (Cooke and Williams, 1970). Therefore in the Netherlands at present much attention is given to the mobility of inorganic phosphates by the Institute of Soil Fertility and of organic phosphates by the Laboratory of Soils and Fertilizers of the State Agricultural University. Generally speaking it is very improbable that the present groundwater is contaminated by P-applications for agriculture of the past.

3.3. Phosphate in the groundwater

Phosphate analyses were carried out in the groundwater of some nature areas. The concentration of ortho-phosphate was in the range of 0.02 to 0.07 mg P.l⁻¹; the total-phosphate concentration ranged from 0.06 to 0.49 P.l⁻¹ (table 3). The results demonstrate the influence of organic matter content on phosphate concentration. The higher the quantity of organic matter in the soil profile, the higher the total-phosphate concentration. The level of the "native" phosphate in groundwater sometimes can be very high resulting from the presence of very eutrophic peat. This emerges from a groundwater quality study in a number of areas throughout the Netherlands (Steenvoorden, 1975). In the peaty areas, situated in the West-Netherlands, the concentration of ortho-phosphate and total-phosphate are more than ten times higher than in the sandy areas (fig. 6). Presumably complex forming is to blame for these high concentrations.

Table 3. Phosphate concentration (mg P.l⁻¹) in the upper meter of the groundwater of some nature areas in the Netherlands

	Poor sand with conifers	Poor sand with deciduous trees	Highmoor on sand with heather	Mesotrophic lowmoor with grass
Ortho-P	0.02	0.04	0.04	0.07
Total-P	0.06	0.08	0.11	0.49

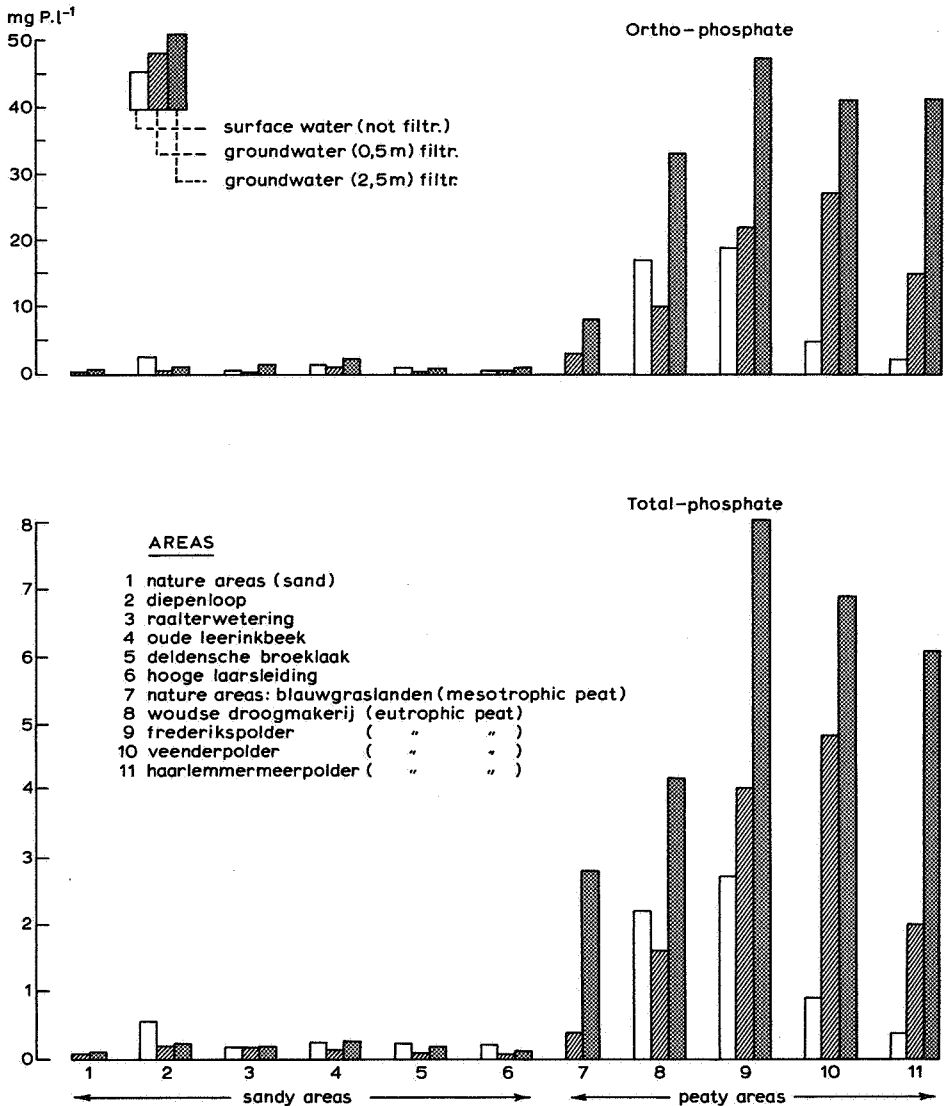

Fig. 6. Ortho-phosphate and total-phosphate concentrations in the surface waters and upper groundwater of some areas in the Netherlands. (Read along the y-axis: 0, 1.0, 2.0 etc. in stead of 0, 10, 20 etc.)

Area number 7 is intermediate between the sandy areas and the other peaty areas and the low concentration at a depth of 0.5 m in the groundwater is the result of the mesotrophic character of the soil.

As already mentioned the history of geological formation has been quite different for

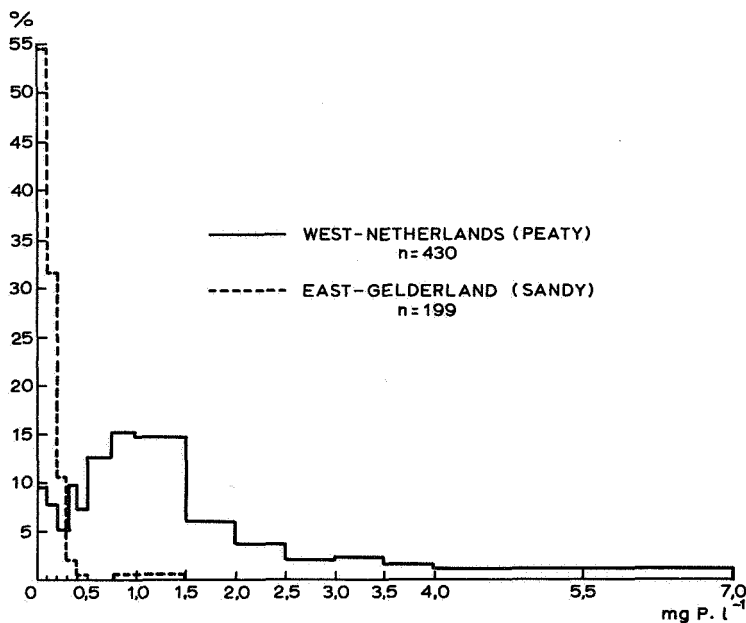

Fig. 7. Distribution (%) of 629 groundwater samples over ortho-phosphate classes (mg P.l^{-1}).

East-Gelderland and the West-Netherlands. The resulting differences in soil composition have had a remarkable influence on the ortho-phosphate concentration. The distribution of the available analyses over some ortho-phosphate classes is given in fig. 7. The mean concentrations are 0.13 mg P.l^{-1} for East-Gelderland and 1.0 mg P.l^{-1} for the West-Netherlands.

4. BIOCIDES*

4.1. General

The term "biocides" covers all materials used to control or combat pests and to interfere in plant growth. The use of biocides started in the second world-war and since then the consumption in the different fields has increased considerably.

Aside from their favourable aspects, their use also can have a detrimental effect on men and animals. Some biocides have an acute or chronic toxicity, even at very low concentrations. The most notorious compounds are the organo-chlorine pesticides (e.g. DDT), which accumulate in the body-fat (Edwards, 1970). Furthermore taste and odour of water can be affected by contamination with biocides of groundwater (Croll, 1972).

*The author is indebted to Dr. M. Leistra of the Laboratory of Insecticide Research, Wageningen, for the information on biocides received.

4.2. Behaviour of biocides in the soil

All biocides come into contact with the soil, either directly, via application on or in the soil, or indirectly via application to inland waters or foliage. The consequences for the quality of groundwater depend on three processes:

- the solubility of the biocide in the soil solution;
- the break-down rate;
- the mobility in the soil.

The importance of each of these processes is determined to a great extent by chemical characteristics of the biocide, as the type and position of the functional groups (hydroxy, methyl, nitro, etc.) in the organic compounds (Edwards, 1966; Bailey and White, 1970). Other factors are of importance too, however. The solubility also depends on the temperature, and the pH whereas the breakdown rate is influenced by temperature, pH and history of the soil. Mobility depends on the interaction between biocide and soil particles. The higher the content of clay and organic matter, the higher the adsorbing capacity of the soil and the less the threat of groundwater contamination (King and McCarty, 1968).

On basis of the functional groups a rough division in biocides can be made with regard to their solubility, breakdown rate and mobility (table 4). Although even within the same group large differences occur, some general remarks can be made.

Table 4. General solubility, mobility and breakdown rate of some groups of biocides

Biocide-group	Solubility	Breakdown rate	Mobility
Chlorinated hydrocarbon	very low	years	very low
Organic phosphorus	low	weeks to months	low
Ureum	low to good	months to year	low to high
Fenoxy-alkyl acid	good	weeks to month	high
Triazine	low	weeks	low
Carbamate	low to good	days to weeks	low

Organo-chlorine biocides are very persistent, have a very low water solubility and exhibit chronic toxicity in men and livestock. They adsorb very strongly to soil particles and leaching to deeper layers of the soil only results from transport of soil particles. The behaviour of organo-chlorine compounds in the soil is demonstrated in fig. 8 for dieldrin, lindane and DDT (Voerman and Besemer, 1970). The mentioned low doses are ones in agricultural practice, applied in three to four gifts whereas the higher doses applied in one gift directly to the soil, are entirely experimental ones. After fifteen years of repeated application only in the top twenty centimeters of the soil residues were found, except

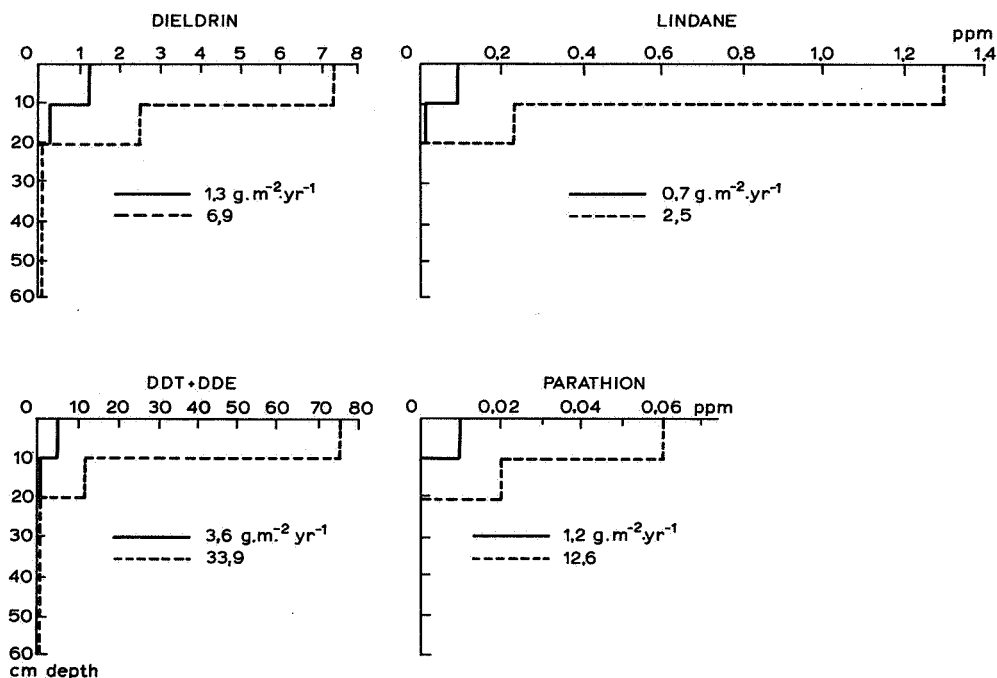

Fig. 8. Distribution in the soil of some organo-chlorine (dieldrin, lindane and DDT + DDE) biocides and an organo-phosphorus compound (parathion) after 15 years of application (after Voerman and Besemer, 1970).

for dieldrin and DDT at the highest dosis where in the layer from 50 to 60 cm depth very low concentrations were found. The latter may have been caused by a faulty sampling technique.

The total persistence of these biocides after fifteen years of application at the lower doses was 20% for DDT plus DDE, 15% for dieldrin and 3% for lindane. At the higher doses the persistence is higher and the percentages are respectively 34, 29 and 8.

Organo-phosphorus compounds show a wide range in water solubility. Mobility in the soil is nearly as low as of organo-chlorine compounds and in addition the degradability is high. Therefore the data in fig. 8 show that parathion is found only in the top twenty centimeters of the soil at very low concentrations. The persistence for both applications was only 0.1%. Organo-phosphorus compounds are cholinesterase inhibiting, but have large differences in their degree of toxicity.

Ureum biocides, among which many herbicides can be found, have a good water solubility and some are rather persistent. In general they are mobile and some are toxic. To control deep rooting weeds a fair mobility and a slow break-down rate are necessary, but this also enhances the risk of groundwater contamination. The herbicide bromacil is

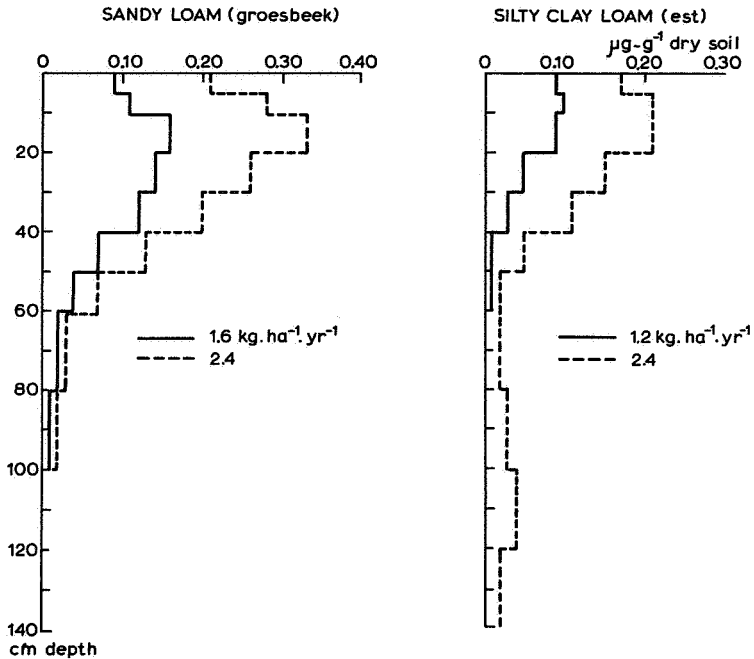

Fig. 9. Distribution in two soil profiles of the ureum biocide bromacil after 6 to 7 years of application (after Leistra et al., 1975).

an example of a mobile ureum compound with a high solubility and a substantial persistence (Leistra et al., 1975). The distribution of bromacil over an orchard soil profile (fig. 9) after six to seven years of application, is markedly different from the distribution of organo-chlorine and organo-phosphorus compounds. Because bromacil is a fumigant supplied to the soil at roughly twenty centimeters depth, the highest concentration is found at 10 to 20 cm depth. Due to its fair solubility and rather high persistence the concentration in the soil only reduces slowly with depth. In the silty clay loam soil of Est, bromacil is found at depths even greater than 1 m.

Other groups of biocides as fenoxo-alkyl acids, triazines, and carbamates can differ in solubility and mobility, but the threat of groundwater pollution is minimal because of their high break-down rate. The half-live ranges from some days to some months. Carbamates have a cholinesterase inhibiting action as the organo-phosphorus compounds.

Knowledge on processes occurring after application of biocides are fragmentary taking into account the hundreds of commercial products in different formulations and the perhaps thousands of break-down products formed in the soil. Only a small amount of research has been done on processes under anaerobic conditions, which can be of importance in the case of groundwater pollution.

4.3. Groundwater pollution

Since 1969 some 75 samples of the deeper groundwater in the Netherlands have been analysed with regard to the occurrence of a large number of organo-chlorine biocides and the cholinesterase inhibiting organo-phosphates and carbamates (Greve, 1975). In none of the samples the detection-limit 0.01 ppb for the organo-chlorine compounds and 0.05 ppb (as paraoxon) for the cholinesterase inhibitors, was exceeded. Analyses of the groundwater near the town Bilthoven also gave negative results (RIV, 1971).

Vrochenskii (1969) detected DDT in 13.8% and lindane in 10.3% in well-water samples of state farms and collectives. Outside the USSR detectable levels of organo-chlorine biocides in groundwater have not been reported. In 74 samples of groundwater from wells and springs in Kent, England (Croll, 1968) and in 35 samples of Italian well-waters organo-chlorine compounds could not be found. Except for the instance recorded by Nicolson and Thoman (1965) that well-waters at 40 to 60 m depth were contaminated with the organo-phosphorous insecticide parathion to a level of 1 ppb, no records of groundwater pollution by other biocides exist.

5. SUMMARY

Nitrogen, phosphate and biocides are widely used in agriculture. Contamination of the groundwater can occur as a result of precipitation excess. The extent to which pollution of groundwater is caused by agricultural activities depends on the processes in the soil.

The nitrogen compounds normally analysed in groundwater are: organic nitrogen, ammonium, nitrite and nitrate. The concentration of nitrite and organic nitrogen generally is low. Nitrate is very mobile in the soil and is primarily responsible for nitrogen leaching. The concentration in the drain water of sandy arable land can be as high as some tens of mg N.l^{-1} . In land under grass the leaching is small as compared to that in arable land, even at a higher level of fertilization. In groundwater nitrate can be involved in denitrification processes when an adequate energy source is available and an oxygen shortage exists. The degree of denitrification is influenced by residence time, as is shown for three brooks with different geo-hydrological conditions. Lack of bio-degradable organic matter might have stopped the denitrification process in the groundwater at some sites in East-Gelderland. Ammonium is very immobile in soils. The concentration found is influenced by soil type and is higher in peaty soils than in sandy soils. In eutrophic peaty areas the concentration can be some tens of mg N.l^{-1} .

Mobility of phosphate is restricted in nearly all soils by the low solubility of inorganic phosphate. Application of manure and fertilizers during many decades did cause an increase of the phosphate content of the soil only in the upper decimeters. Transport of inorganic phosphate is relatively quick in soils rich in organic matter. Contamination of groundwater in the past by the P-applications in agriculture is very improbable. The

concentration of total phosphate in sandy areas will normally be some tenths of mg P.l⁻¹. In peaty areas the concentration can be much higher, probably as a result of complex-formation.

Biocides can be roughly divided in: organo-chlorine, organo-phosphorus, ureum, fenoxo-alkyl acid, triazine, carbamate compounds and some less important groups. Contamination of groundwater with a biocide can occur when the compound has a good water-solubility and mobility in the soil and moreover a low break-down rate. These conditions generally are only met by the group of ureum compounds. Up to now only in two countries some isolated incidents of groundwater pollution have been recorded. This concerned contamination with organo-chlorine and organo-phosphorus compounds.

LITERATURE

- BAILEY, G.W. and J.L. WHITE (1970) – Residue Reviews 32, 29.
- BON, J. (1973) – Groundwater hydrology of five small watersheds (in Dutch). Nota 770. ICW. Wageningen.
- CHAO TYNG-TSAIR and Wybe Kroontje (1966) – Inorganic nitrogen transformations through the oxidation and reduction of iron. Soil Sci Soc. Amer. Proc. 30, 193-196.
- COOKE, G.W. and R.J.B. Williams (1970) – Losses of nitrogen and phosphorus from agricultural land. Water Treatment & Exam. 19,3, 253-277.
- CROLL, B.T. (1969) – Organo-chlorine pesticides in water, part. I. Water Treatment and Exam. 18: 255-274.
(1972) – The impact of organic pesticides and herbicides upon groundwater pollution. Groundwater pollution conference, University of Reading. 219-233.
- EDWARDS, C.A. (1966) – Residue Reviews 13,83.
(1970) – Persistent pesticides in the environment, 78 pp., CRC Monoscience series. Butterworth, London.
- ERNST, L.F. (1973) – The calculation of transport time for groundwater in the saturated zone (in Dutch). Nota 755. ICW, Wageningen.
- ERNST, L.F., N.H. DE RIDDER and J.J. DE VRIES (1970) – A geohydrologic study of East-Gelderland. Geologie en Mijnbouw, 49,6: 457-488.
- FWPCA (1969) – Methods for chemical analyses of water and wastes. Federal Water Pollution Control Administration. Cincinnati, Ohio.
- GREVE, P.A. (1975) – Rijksinstituut voor Volksgezondheid, private communication.
- GRASSO, C. et al. (1968) – Detection of pesticides in underground waters. Ann. Sanita. Publ. 29, 4: 1029-1032.
- HAAN, F.A.M. DE (1975) – Interaction-mechanisms in soil as related to soil pollution and groundwater quality. Committee for hydrological research TNO. Proceedings and informations no.21. The Hague, p. 34-51.
- HENKENS, Ch.H. (1972) – Fertilizer and the quality of surface water. Stikstof 15, 28-41.
- HOEKS, J. (1975) – Pollution of soil and groundwater from land disposal of solid wastes. Committee for hydrological research TNO. Proceedings and information no. 21. The Hague, p. 70-86.
- HUNTJES, J.L.M. (1972) – Nitrogen fertilization on grassland and the eutrophication of the surface water (in Dutch). Stikstof 70,6: 412-416.
- KING, P.H. and P.L. McCARTY (1968) – A chromatographic model for predicting pesticide migration in soils. Soil Science 106: 248-262.

- KOLENBRANDER, G.J. (1972) – The eutrophication of surface water by agriculture and the urban population. *Stikstof* 15: 56-68.
- LEISTRA, M., J.H. SMELT and R. ZANDVOORT (1975) – Concentrations of bromacil in orchard soils after repeated annual applications.
- LIPS, H.J.M., B. BULTEN en J. VAN PUFFELEN (1969) – Change of the water quality by infiltration in the dunes (in Dutch). Rapport Werkgroep Infiltratie Rivierwater in de duinen.
- MURPHY, J. and J.P. RILEY (1962) – *Analytica Chemica Acta*, 27: 31-36.
- NICHOLSON, H.P. and J.R. THOMAN (1965) – Pesticide persistence in public water, their detection and removal. Research in pesticides New York, Academic press, p. 181.
- OOSTEROM, H.P. en J.H.A.M. STEENVOORDEN (1974) – Chemical and physical composition of ground- and surface water in some areas (in Dutch). Nota 810 ICW, Wageningen.
- PROVINCIALE LANDBOUWKUNDIGE DIENST GELDERLAND (1972) – The structure of agriculture in Gelderland (in Dutch), 66 pp.
- REES VELLINGA, E. VAN (1972) – Some results of a geo-hydrological research in the Middle-Western Netherlands (in Dutch) Nota 679, ICW, Wageningen.
- RIJKSINSTITUUT VOOR DE VOLKSGEZONDHEID (1971) – Samenvattend rapport over 1971, Tox. 36.
- STEENVOORDEN, J.H.A.M. (1975) – The quality of ground- and surface water in rural areas (in Dutch). *Waterschapsbelangen* 59,24: 443-449.
- STEVENSON and SWABY (1964) – Nitrosation of soil organic matter. *Soil Sc.Soc.Proc.* 773-778.
- STUMM, W. and J.J. MORGAN (1970) – *Aquatic Chemistry. An introduction emphasizing chemical equilibria in natural waters.* Wiley-Interscience.
- UNITED NATIONS. Economic and Social Council (1974) – The pollution of waters by agriculture and forestry. Proc. of a seminar organized by the Committee on water problems in Vienna. 15-20 Octobre, 1973. Vol. II, p. 131.
- VOERMAN, S. and A.F.H. BESEMER (1970) – Residues of dieldrin, lindane, DDT and parathion in a light sandy soil after repeated application throughout a period of 15 years. *Agr. and Food Chem.* 18(4): 717-719.
- VRIES, O. DE en F. VAN DER PAUW (1937) – The leaching of some phosphates in different Dutch soils (in Dutch). *Versl. Landbouwk. Onderz.* 43A, 44 pp.
- VROCHENSKII, K.K. (1968) – Pesticide levels in water of reservoirs and sources of water supply. *Gig. Sanit.* 33, 11: 69-72.
- WOLDENDORP (1963) – The influence of living plants on denitrification *Meded. Landbouwhogeschool te Wageningen, Nederland* 63(13). Veenman en Zn, N.V., Wageningen.

POLLUTION OF SOIL AND GROUNDWATER FROM LAND DISPOSAL OF SOLID WASTES

J. HOEKS

Senior scientist, Institute for Land and Water Management Research, Wageningen, The Netherlands

1. INTRODUCTION

In the Netherlands three main processing techniques are used to dispose of solid wastes, i.e. incineration, composting and land disposal. The first two techniques leave non-combustible rubbish and ashes, respectively non-compostable waste, which have to be disposed of on land (or in the sea).

During the past years the importance of incineration and composting has increased, but land disposal is still the most common technique and is supposed to continue to be so in the near future. The latest figures derived from SVA (1975) indicate that in the Netherlands 25.7% of the municipal refuse is incinerated, 17.4% is composted and 56.9% is disposed of by land disposal. In 1974 20.2% of the municipal refuse (a year earlier this figure was only 9.3%) is dumped in so-called "sanitary landfills", i.e. an engineering method of disposal of refuse on land, creating a minimum of nuisance from an environmental and sanitary point of view.

In the humid climate of the Netherlands the mean annual precipitation surplus (rainfall minus evaporation) is about 250 mm. This will percolate through the landfill and the leachate, more or less contaminated, will penetrate the subsoil and feed the groundwater. The infiltration can more or less be controlled by applying an impermeable cover material or by compression of the refuse. It is, however, practically impossible to completely prevent infiltration of precipitation. So the problem of selecting suitable sites for land disposal of solid wastes is the choosing areas with such hydrological conditions that harmful effects of the leachate contaminants are not encountered.

Once the leachate has penetrated into the subsoil it is important to know the speed with which the different contaminants are transported in soil and groundwater. Therefore the hydrological situation of the area around a waste disposal site has to be known since it controls the direction and velocity of groundwater flow. Apart from transport processes, accumulation processes like cation exchange, precipitation and biochemical reactions are important as they largely determine the mobility of a contaminant in soil (De Haan, 1975).

2. CHARACTERISTICS OF THE LEACHATE

The chemical composition of the leachate depends on the amount of soluble salts and decomposable compounds in the refuse. Non-soluble organic compounds may be decomposed by bacterial action to soluble intermediates and end products. The nature and composition of the solid waste, the age of the landfill, the percolation rate and the time span of contact between percolate and refuse are important factors in determining the ultimate leachate contamination.

In literature large differences in the composition of leachate are found which are partly due to the factors mentioned above, but also to the different ways of collecting and analysing the leachate samples. In table 1 a few data on leachate composition are given. These data were collected in a comparable way from newly dumped refuse. It is clear that the leachate is a grossly polluted liquid, with both an organic and inorganic load.

Because the refuse when dumped is rather dry, it will take some time before the moisture content has reached field capacity. Usually one meter of fresh refuse can store 120 to 180 mm of water in addition to the initial water content. So under Dutch climatic conditions it will take about half-a-year before a leachate is generated from a one-meter-

Table 1. Chemical composition of leachates from newly dumped refuse

Component		SVA (1974)	Zanoni (1973)	Mead and Wilkie (1972)
COD	mg/l	63,900	—	—
BOD	mg/l	—	33,100	32,400
Cl	mg/l	3,950	1,810	2,240
SO ₄	mg/l	1,740	560	630
HCO ₃	mg/l	14,430	—	—
Organic NH ₄ -N	mg/l	390	320	550
Inorganic NH ₄ -N	mg/l	1,410	790	845
NO ₃ -N	mg/l	—	—	—
Total-PO ₄	mg/l	25.5	9.6	—
Ortho-PO ₄	mg/l	6.8	—	—
Total Fe	mg/l	1,590	270	305
Ca	mg/l	2,625	2,190	—
Mg	mg/l	450	340	—
Na	mg/l	2,990	1,470	1,805
K	mg/l	1,800	1,115	1,860
pH		5.7	—	5.6
EC (25°C)	μS/cm	32,400	—	—

thick layer of refuse. During summer it may take a few months more and in winter it may take only two to three months.

Though the leachate volume is largely dependent on the precipitation surplus, it appeared to be rather constant throughout the year with only slight seasonal fluctuations (SVA, 1973), which can be explained by the hydrologic buffering capacity of the refuse.

3. GEOHYDROLOGICAL ASPECTS OF GROUNDWATER POLLUTION

Before arriving at the phreatic surface the leachate percolates through unsaturated soil. This transport is mainly vertical. Once the leachate has reached the groundwater the pathway of contaminants is that of the groundwater flow, and factors as permeability of cover deposits, depth of impermeable layers and hydraulic head gradients in the aquifer become important. The depth of penetration in the aquifer is also dependent on the distance from the nearest groundwater divide ($L-x$) and from the nearest drainage channel (x) (fig. 1).

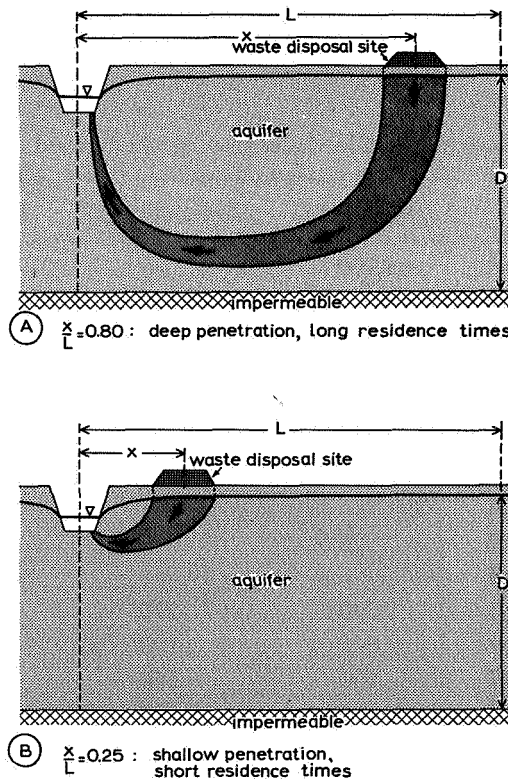

Fig. 1. Schematic presentation of the influence of geohydrological conditions on transport of contaminants from a waste disposal site through an aquifer towards a drainage channel.

If the leachate penetrates deeply into the aquifer long transport times, i.e. time needed for transport to open water, prevail (Ernst, 1973). The longer the residence time of the leachate in the groundwater the greater the chance for contaminants to be removed by (bio)chemical processes in the soil.

The knowledge of transport times of groundwater can be helpful in predicting after what time and to what extent the surface water in the nearby drainage system will be influenced by the presence of a landfill. In this context it should be remembered that convective flow in porous systems creates a dispersion process, so a "break-through" of a salt carried by groundwater flow will occur earlier than expected on basis of mean flow velocity.

In literature several cases of groundwater pollution from landfills have been described. Most authors report a drastic decrease in the concentration of pollutants within rather short distances from the waste disposal site. In a number of cases the possible great depth of the aquifer might have been overlooked because groundwater quality was determined only at a single depth. Sometimes geohydrological data on type and thickness of aquifers are missing at all.

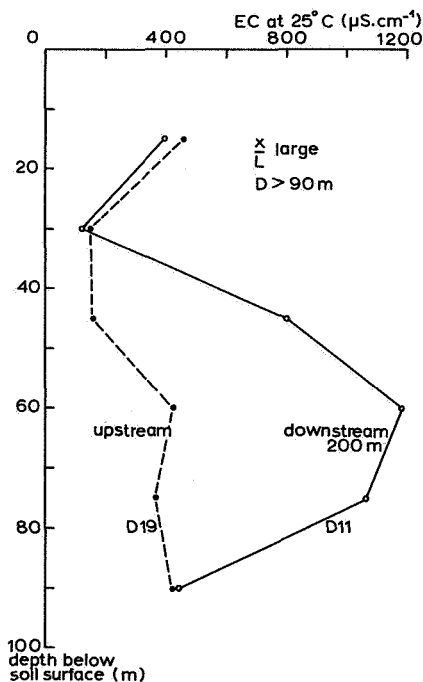

Fig. 2. Electric conductivity (EC) profiles indicating deep penetration of the leachate from a waste disposal site into an aquifer more than 90 m thick (see also table 3).

An example of rather deep penetration of a leachate into the aquifer is given in fig. 2, where the electric conductivity (EC) of the groundwater is plotted versus depth, as well upstream as downstream of the waste disposal site. The leachate-contaminated flowpath in the aquifer here reached a depth of 45 to 75 m below soil surface. The landfill is situated close to the groundwater divide (x/L large). The exact depth of the aquifer could not be determined but is more than 90 m.

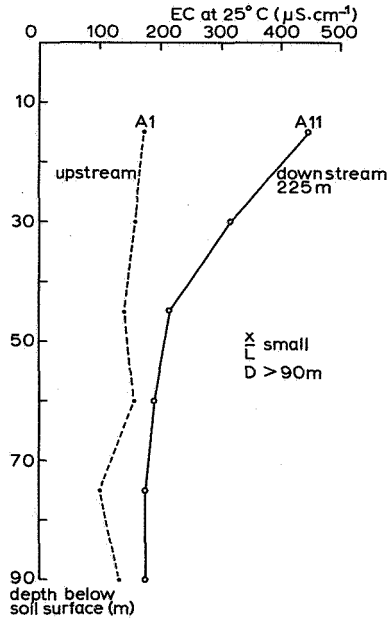

Fig. 3. Electric conductivity (EC) profiles indicating shallow penetration of the leachate from a waste disposal site into an aquifer more than 90 m thick (see also table 4).

In the example of fig. 3 the aquifer depth also is more than 90 m. The penetration depth of the leachate, however, is rather shallow (about 30 to 40 m). In this case the waste disposal site is located further away from the nearest groundwater divide than from the drainage channel (x/L small).

In thin aquifers, flow velocities are often high resulting in serious pollution of the groundwater over large distances. Exler (1972) describes such a situation. In his case the aquifer was only 3 to 5 m thick, with flow velocities of 5 to 10 m per day. The groundwater was found to be seriously polluted over a distance of more than 3000 m downstream of the waste disposal site.

Fig. 4 gives a situation where the aquifer is about 15 m thick. The main flowpath of the leachate has penetrated the aquifer up to a depth of 10 to 12 m, as is clear from the

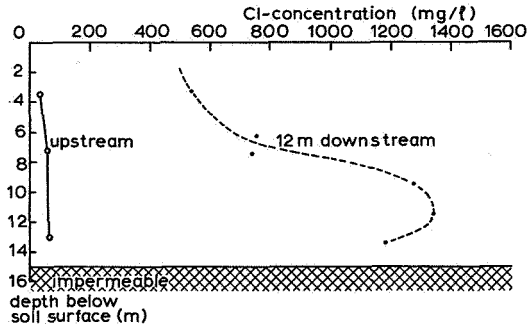

Fig. 4. Cl-content of the groundwater indicating penetration of the leachate from a waste disposal site into a 15 m thick aquifer (data after SVA, 1974).

rather high (and still increasing) chloride concentrations in the groundwater (data after SVA, 1974). In this case the first increase in concentration was observed at the end of 1972; dumping of refuse started about three years earlier.

4. INFLUENCE OF THE LEACHATE ON GROUNDWATER QUALITY

4.1. General

In soil only few components of the leachate are transported without being influenced by interactions with the solid phase and by biochemical reactions. These components, of which the Cl-ion is the most common one, can act as a tracer of pollution in groundwater.

Almost all other components of the leachate are subjected to interactions with the soil, as ion exchange on electrically (mainly negatively) charged surfaces and precipitation of poorly soluble products originating from reactions with ions present in the soil.

Apart from these chemical processes, biochemical reactions caused by bacterial activity will be important for a number of components. According to Golwer et al. (1969) three successive biochemical zones are to be distinguished in the groundwater around waste disposal sites (as also around other point sources of pollution), viz.:

- a reduction zone surrounding the waste disposal site; here the groundwater is anaerobic because of organic loading. So NO_3^- , Fe^{3+} , Mn^{4+} and ultimately also SO_4^{2-} will be reduced, while organic substances will be broken down anaerobically by bacteria;
- a transition zone; temporarily the groundwater in this zone contains dissolved oxygen, so alternately the conditions here are aerobic and anaerobic;
- an oxidation zone at larger distances from the waste disposal site; here dissolved oxygen always is present in the groundwater.

In the Netherlands this classification of biochemical zones is only useful in sandy areas where the groundwater normally is aerobic (eastern and southern part of the country). Especially in the western part of the country the native groundwater is often already anaerobic resulting from dissolved organic matter originating from peaty layers in the soil profile. Here the nitrogen in the groundwater is found mainly in the form of ammonium while nitrate and nitrite are absent (Steenvoorden en Oosterom, 1973).

From the data in table 1 it was clear that the leachate from refuse dumps is a grossly polluted liquid with a large number of contaminants. The most harmful of them are supposed to be:

- dissolved organic compounds, especially the more persistent ones, because they may affect taste and odor of the groundwater;
- nitrogen compounds, because of eutrophication problems in surface waters and harmful effects of high NO_3 -contents in drinking water;
- heavy metals, because of the toxic-effects; in table 1 data on heavy metal concentrations were not given. In literature such data are very scarce and not always reliable.

The other components as sodium, potassium, chloride and the hardness-causing ions calcium and magnesium are supposed to be rather harmless, though they may pose problems when groundwater is used for industrial purposes (e.g. process water or boiler-feed water).

4.2. Dissolved organic compounds

In the reduction zone of the groundwater biochemical reactions are performed by facultatively anaerobic bacteria and strictly anaerobic bacteria. Well known reactions are reduction of nitrates (denitrification), iron, manganese, and sulfates. These reductions require the presence of organic compounds, acting as electron donors. The organic

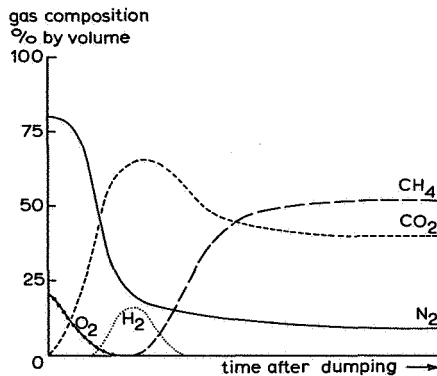

Fig. 5. Subsequent stages of gas production in a sanitary landfill (after Farquhar as cited by Zanoni, 1973).

compounds are broken down to organic acids and CO_2 , and ultimately CH_4 is formed. This process starts already rather early in the landfill as can be seen from fig. 5 which illustrates the successive stages in gas production in a landfill (Farquhar, cited by Zanoni, 1973). The process of anaerobic decomposition continues during percolation of the leachate in the unsaturated part of the underlying soil because the entire soil below a landfill is anaerobic as may be seen from data on O_2 -contents and redox potentials (table 2).

Table 2. Oxygen and carbon dioxide contents in the gaseous phase of the soil and redox potentials below a landfill in Markelo/Rijssen, The Netherlands (n.d. = not determined)

Depth below landfill (cm)	O_2 -content (vol. %)	CO_2 -content (vol. %)	CH_4 present	Redox potential (mV)
20	1	38	+	n.d.
60	1	32	+	n.d.
10	n.d.	n.d.	n.d.	-166
70	n.d.	n.d.	n.d.	-126
120	n.d.	n.d.	n.d.	-166

Because of the anaerobic process the COD of the leachate will decrease during transport through the soil. The residence time of the leachate in soil and groundwater is important for the ultimate COD-value of the groundwater. The decomposition rate in soil can be determined by means of laboratory experiments with soil columns. However, one should be cautious when applying such data to field conditions. Fig. 6A illustrates some results from such a column experiment with leachate from a waste disposal site. As is normally done for such experiments, the results are presented as so-called "break-through" curves. This means that the ratio between the concentration in the effluent (c_e) and the original concentration in the leachate (c_o) is plotted against the volume of effluent that passed the column. The latter is expressed as the number of times the water-filled pore volume of the column is displaced so as the ratio between the percolated volume V and the water-filled pore volume V_o of the column. The Cl-curve can be considered to be a reference curve for ions that do not show interactions with the soil. The difference between the COD-curve and the Cl-curve then must be caused by (anaerobic) bacterial decomposition. The rate of decomposition can be calculated from this difference. Since the ultimate COD-decrease is about 7% (fig. 6B), the moisture content in the column 15.8%, the initial concentration c_o in the influent 21.6 mg/ml and the residence time 22.8 days, the decay rate is calculated as being $0.07 \times 0.158 \times 21.6 / 22.8 = 1.05 \times 10^{-2} \text{ mg.cm}^{-3} \cdot \text{day}^{-1}$.

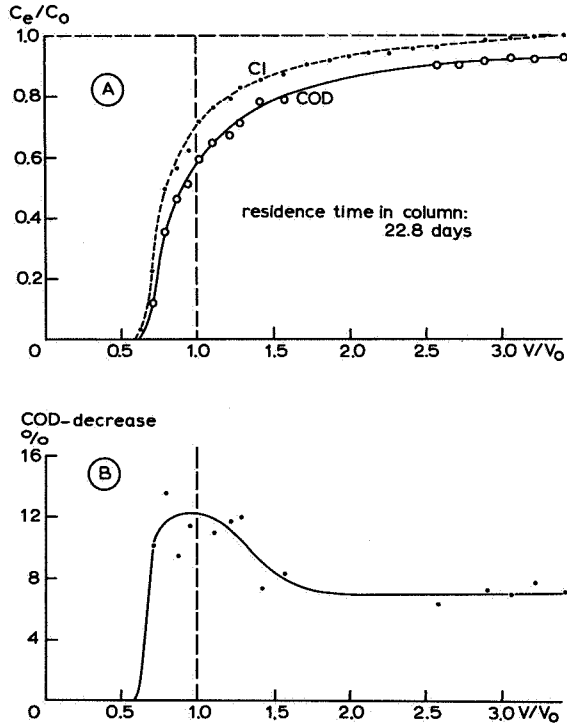

Fig. 6. Break-through curves for Cl and COD (c_e = value in effluent; c_0 = original concentration in leachate) from column experiments with leachate from a waste disposal site under anaerobic conditions (A) and the calculation of the decrease in COD from these curves (B); V = percolated volume, V_0 = water-filled pore volume of column, temperature about 21 °C.

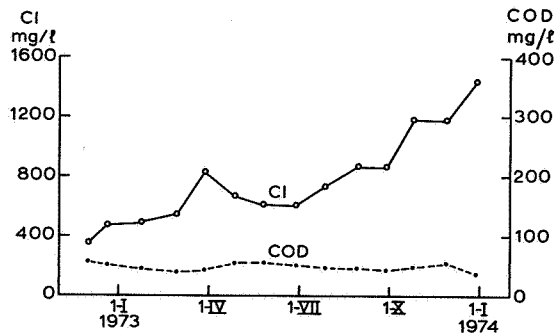

Fig. 7. Effect of waste disposal on Cl and COD concentrations in the groundwater 12 m downstream of a disposal site at a depth of 13 to 14 m below soil surface. Dumping of refuse started in November 1969 (same disposal site as in fig. 4; data after SVA, 1974).

Data (after SVA, 1974) of a field situation are presented in fig. 7. About 3 years after the start of refuse dumping a "break-through" of chloride was observed in a groundwater observation well 12 m downstream of the disposal site. The COD-value almost did not change during the period of observation. So the organic compounds relatively to chloride are held back, probably mainly by bacterial decomposition. This does not mean, however, that the COD-value never will increase in this observation well.

In the case of fig. 2, the COD-value was slightly higher in the leachate-contaminated flowpath, at a depth of 60 m below soil surface (see table 3). Though the initial concentrations in the leachate there were not known, the decrease in COD seems to be much higher than the decrease in Cl. It would be interesting to find out what kind of organic compounds are left and how persistent they are. Since NO_3 -ions are missing at this depth, reducing conditions are certainly prevailing. The native groundwater is already anaerobic, however, since at this depth NO_3 -ions are also missing in the groundwater upstream of the waste disposal site.

4.3. Nitrogen compounds

In the leachate nitrogen is mainly present as inorganic ammonium and organic nitrogen compounds. The latter will be broken down by bacterial activity and nitrogen is liberated as inorganic ammonium. In the reduction zone nitrogen will remain in the form of inorganic ammonium. The NH_4^+ -ions may be adsorbed by the cation exchange complex in the soil but the presence of high-valent ions like Ca^{2+} , Mg^{2+} and Fe^{2+} will significantly limit the adsorption of the monovalent NH_4^+ -ions. Therefore the NH_4^+ -ion can be expected to be rather mobile, especially in sandy soils low in cation exchange capacity. Table 3 shows that the total NH_4 -content (organic + inorganic) and inorganic NH_4^+ -concentration are fairly high at 60 m depth when compared with the normal upstream situation.

Once the NH_4^+ -ion has penetrated into the oxidation zone, it will be oxidized to NO_3 (nitrification). Thus, at larger distances from the waste disposal site higher NO_3 -concentrations can be expected to occur. Exler's data (1972) on the NO_3 -distribution around the waste disposal site he investigated, indicate a reduction zone extending as far as 1500 m in downstream direction. In the subsequent oxidation zone he indeed found rather high NO_3 -concentrations (more than 100 mg NO_3/l). The data in table 4 show the same picture. It is possible that the high nitrate concentrations further downstream of the waste disposal site are partly due to agricultural activities in this area.

4.4. Heavy metals

Little is known about the heavy metal content of a leachate from solid waste. Zanoni (1973) cites some data from Schoenberger and Fungaroli concerning a leachate from incinerator residues, viz. 0.95 mg Zn/l, 1.15 Cu/l, 1.53 mg Cr/l and 1.16 mg Pb/l. Especially certain industrial wastes, e.g. from galvanic industries, are supposed to be sources of heavy metal pollution if dumped at waste disposal sites.

Table 3. Groundwater composition at various depths below soil surface about 200 m downstream of a waste disposal site (D11). The groundwater composition upstream (D19) is given as reference

Depth below soil surface (m)	pH	EC 25°C ($\mu\text{S}\cdot\text{cm}^{-1}$)	COD	Total $\text{NH}_4\text{-N}$ ($\text{mg}\cdot\text{l}^{-1}$)	Inorg. $\text{NH}_4\text{-N}$ ($\text{mg}\cdot\text{l}^{-1}$)	$\text{NO}_3\text{-N}$ ($\text{mg}\cdot\text{l}^{-1}$)	Total PO_4 ($\text{mg}\cdot\text{l}^{-1}$)	Ortho PO_4 ($\text{mg}\cdot\text{l}^{-1}$)	Cl ($\text{mg}\cdot\text{l}^{-1}$)	Total Fe ($\text{mg}\cdot\text{l}^{-1}$)	HCO_3 ($\text{mg}\cdot\text{l}^{-1}$)	SO_4 ($\text{mg}\cdot\text{l}^{-1}$)	Total hardness ($^\circ\text{DH}$)
D19-upstream													
15	5.1	454	8	0.70	0.34	32.0	0.92	0.44	21	1.1	6	72	9.2
30	5.5	144	23	0.84	0.34	<0.2	0.70	0.14	27	8.8	11	10	1.5
45	5.7	158	51	0.84	0.34	<0.2	1.5	0.40	20	7.4	45	15	2.3
60	6.9	420	15	1.3	0.34	<0.2	0.68	0.09	21	8.3	171	64	11.0
75	6.8	368	17	1.3	0.84	<0.2	0.74	0.14	14	8.2	206	16	9.0
90	6.9	426	18	1.6	1.1	<0.2	0.76	0.09	9	25	281	6	12.0
D11-downstream													
15	5.1	384	10	0.86	0.36	15.0	0.10	<0.03	51	1.8	9	49	6.2
30	5.9	164	15	0.59	0.44	<0.2	0.42	<0.03	28	11	24	23	1.6
45	6.7	640	30	1.3	0.78	<0.2	0.88	<0.03	87	14	255	10	13.9
60	6.5	1120	65	6.6	5.2	<0.2	0.58	<0.03	182	24	371	34	19.9
75	6.6	1040	40	1.3	0.37	<0.2	0.74	<0.03	197	18	373	14	21.7
90	6.9	680	20	1.5	0.86	<0.2	0.58	<0.03	71	8.0	321	5	17.1

Table 4. Groundwater composition at various depths below soil surface about 20 m (A9) and 225 m (A11) downstream of a waste disposal site. The groundwater quality upstream (A1) is given as reference

Depth below soil surface (m)	pH	EC 25°C ($\mu\text{S.cm}^{-1}$)	COD (mg.l^{-1})	Total $\text{NH}_4\text{-N}$ (mg.l^{-1})	Inorg. $\text{NH}_4\text{-N}$ (mg.l^{-1})	$\text{NO}_3\text{-N}$ (mg.l^{-1})	Total PO_4 (mg.l^{-1})	Ortho PO_4 (mg.l^{-1})	Cl (mg.l^{-1})	Fe (mg.l^{-1})	HCO_3 (mg.l^{-1})	SO_4 (mg.l^{-1})	Total hardness ($^{\circ}\text{DH}$)
A1-upstream													
15	6.1	172	7	0.45	0.36	0.69	0.24	<0.03	32	2.5	16	63	1.7
30	6.2	158	5	3.7	0.40	3.7	1.50	0.05	13	-	17	40	2.0
45	6.7	142	5	0.40	0.17	1.8	0.27	0.15	7	1.1	22	62	2.2
60	7.6	156	5	0.35	0.17	0.69	0.21	0.16	10	0.43	50	36	3.1
75	6.5	102	5	0.49	0.25	1.6	0.19	0.06	12	0.04	17	18	0.9
90	6.9	132	5	0.35	0.17	0.69	0.21	0.07	8	1.2	55	27	2.6
A9 -20 m downstream													
9.5	6.4	1520	89	46	41	<0.2	0.15	<0.03	123	1.9	612	107	13.9
12.5	5.1	800	34	2.3	0.22	<0.2	0.61	<0.03	141	17.0	44	117	6.9
16	5.2	518	15	0.35	0.17	<0.2	0.53	0.05	72	7.8	33	108	3.1
22	6.5	1340	56	14.7	11.5	<0.2	0.41	<0.03	134	1.8	517	147	21.9
A11 -200 m downstream													
15	5.4	446	5	0.35	0.22	23	0.55	0.03	41	8.6	11	48	7.9
30	5.9	314	5	0.56	0.39	9.7	0.28	0.03	44	1.0	18	24	4.0
45	7.5	214	5	0.49	0.35	5.1	0.24	0.15	17	0.1	39	22	3.1
60	7.2	190	5	0.42	0.25	3.7	0.26	0.05	22	0.3	28	16	3.0
75	7.1	174	5	0.49	0.22	<0.2	0.30	0.03	17	1.0	45	22	3.2
90	7.0	176	5	0.42	0.11	<0.2	0.23	0.03	13	3.7	50	20	3.0

Data from SVA (1974) indicate that especially Zn and Ni contents in the leachate from a landfill are high. The data given in table 5 were mentioned for various metals in the leachate.

Data of Golwer et al. (1969) and SVA (1974) show that downstream of a landfill the heavy metal content tends to be lower than in the original groundwater. A possible explanation for this is that heavy metals precipitate as poorly soluble sulfides and car-

Table 5. Concentrations of heavy metals in the leachate of a landfill (after SVA, 1974)

Pb : 0.020-0.300 mg/l	Cd : 0.250 mg/l
Cu : 0.045-0.300 mg/l	As : 0.110-0.160 mg/l
Zn : 28-30 mg/l	Ni : 0.600-1.050 mg/l
Cr : 0.120 mg/l	

bonates in the reduction zone. Moreover adsorption by the cation exchange complex of the soil is considered to be very effective for removal of heavy metals from waste water.

4.5. *Other (rather harmless) components*

The cations Na^+ , K^+ , Ca^{2+} , Mg^{2+} and Fe^{2+} generally are present in large amounts in the leachate. Ion exchange in the soil can be very important for removal of these ions, if first the cation exchange capacity is sufficiently high and secondly the saturation of the exchange complex with respect to these ions is low.

Table 6. Composition of the adsorption complex of air-dry soil in its original state and underneath a landfill (53 to 56 cm below refuse base) in Markelo/Rijssen, The Netherlands (after Breeuwsma and Van Engers, 1974)

Cation	Composition of the soil adsorption complex (%)	
	underneath landfill	reference sample
K	9.8	3.5
Na	3.3	1.2
Ca	48.2	0.0
Mg	16.7	0.8
Fe	3.3	0.0
Mn	18.6	0.2
Zn	0.1	0.1
Al	0.0	94.2
CEC (meq/100 g)	3.40	7.73

Apgar and Langmuir (1971) found that the base saturation in leachate-contaminated soil was much higher than in the corresponding uncontaminated soil. This also was found by Breeuwsma and Van Engers (1974) who report data on the composition of the cation exchange complex (table 6). These data were collected from a sandy soil with originally fairly low pH-values (pH-KCl: 4.0 to 4.3). In the reference samples the per cent base saturation therefore is low (about 25 to 50%). In the leachate-contaminated samples pH-values were much higher (pH-KCl: 5 to 7) and so was the per cent base saturation (about 70 to 90%). In the contaminated soil the Al-ion present in the reference samples, was completely expelled from the exchange complex. The released Al may have precipitated with phosphate from the leachate as poorly soluble AlPO_4 .

In table 7 the total yearly amount of cations from a waste disposal site (expressed as annual load per cm^2 of soil) is compared with the total cation exchange capacity of a number of soils. From these figures it can be concluded that especially in soils with rather high clay contents the process of cation exchange may contribute considerably to the removal of pollutants.

Some of the cations may be precipitated. This is particularly true for Ca^{2+} , Mg^{2+} and Fe^{2+} , but also for anions as PO_4^{3-} . Because of biochemical processes the production of CO_2 in the reduction zone is high, resulting in high bicarbonate (HCO_3^-) concentrations (see also table 3 and 4). This, together with low redox potentials and rather high pH-values, makes conditions favourable for precipitation of carbonates. Investigations of Breeuwsma and Van Engers (1974) indicated precipitation of CaCO_3 , MgCO_3 , FeCO_3 and MnCO_3 and to a minor extent also of FeS . This precipitation mainly was located in thin fine-textured layers of the otherwise sandy soil profile just beneath the landfill.

Phosphates are known to be very immobile in soil because of their precipitation with Fe-, Al- and Ca-ions, commonly present in soil (Beek and De Haan, 1973). Therefore hardly any increase in ortho-phosphate concentration can be detected in the vicinity of waste disposal sites (see also table 3 and 4). In the leachate itself phosphate mainly is present as organic phosphate, and in this form it probably is more mobile. During decomposition of the organic substances phosphate will be released as inorganic ortho-phosphate, but this soon will be precipitated.

Sulfates often are supposed to be reduced to sulfides in the reduction zone.

Several data of leachate composition and groundwater quality in the near vicinity of a waste disposal site indicate, however, rather high sulfate concentrations (see table 3 and 4). The reason for this may be that reduction of sulfate is hampered by unfavourable conditions for bacterial activity.

5. DISCUSSION

Especially under humid climatic conditions land disposal of solid wastes may cause groundwater pollution. It has been explained that the impact of a leachate from a

Table 7. Cation and anion load of the soil underneath a landfill and the potential cation exchange capacity of some soils

Ion	Concentration of leachate* (mg.l ⁻¹)	Loading of the soil** (mg.cm ⁻² .yr ⁻¹)	Loading of the soil** (meq.cm ⁻² .yr ⁻¹)	Estimated exchange capacity in the upper meter of the soil (meq. per cm ² soil surface)
NH ₄ ⁺	1 500	30	1.67	— sandy soil with loamy layers: 3 meq.cm ⁻²
Na ⁺	3 000	60	2.61	
K ⁺	1 800	36	0.92	
Ca ²⁺	2 500	50	2.50	— humic sandy soil: 10 meq.cm ⁻²
Mg ²⁺	450	9	0.75	
Fe ²⁺	1 500	30	1.07	
total cations			9.52	— sandy clay soil: 20 meq.cm ⁻²
Cl ⁻	4 000	80	2.25	— clay soil: 50 meq.cm ⁻²
HCO ₃ ⁻	14 500	290	4.75	
NO ₃ ⁻	10	0.2	negl.	
SO ₄ ²⁻	1 750	35	0.73	
total anions			7.73	

* Round figures from the landfill Ambt Delden.

** Annual leachate volume is estimated at 200 mm.yr⁻¹.

waste disposal site on groundwater quality in the near vicinity is largely dependent on geohydrological conditions. Especially where aquifers are thin and high flow velocities occur, serious pollution of groundwater has been observed over large distances downstream of the waste disposal site.

Geohydrological conditions are supposed to be favourable when the transport of the leachate through the aquifer to surface water takes a long time, giving ample opportunity for biological decomposition, adsorption and precipitation of contaminants. These conditions can be achieved by locating the waste disposal site close to the groundwater divide, preferably in areas with thick aquifers. Harmful concentrations of contaminants will then be limited to the immediate vicinity of the disposal site (to some hundreds of meters in downstream direction).

One might ask what will happen in the long run. What will happen in reality, is not yet fully understood and the answer therefore remains rather speculative. After ending waste disposal the leachate will gradually become less polluted and ultimately the anaerobic situation in and just below the refuse will disappear and aerobic conditions will be reestablished. Contaminants which earlier have been adsorbed and precipitated, will then partly be released into the soil solution and the accumulation zone will shift further away from the land disposal site.

If geohydrological conditions are unfavourable, e.g. if aquifers are thin with high flow velocities occurring, there hardly is time available for decomposition processes. In that case measures should be taken to prevent serious pollution of the aquifer itself and the neighbouring open water. These measures can consist of collecting and treating the leachate, e.g. by constructing an intercepting trench along the downstream edge of the waste disposal site.

LITERATURE

- APGAR, M.A. and D. LANGMUIR (1971) – Groundwater pollution potential of a landfill above the water table. *Groundwater* 9, p. 76-96.
- BEEK, J. and F.A.M. DE HAAN (1973) – Phosphate removal by soil in relation to waste disposal. *Proc. Int. Conf. Land for Waste Management, Ottawa*, p. 77-86.
- BREEUWSMA, A. and L.E. VAN ENGERS (1974) – Effect of land disposal of solid wastes on soil and groundwater (in Dutch). *Stiboka Rep. 1156, SVA/947*, 19 pp.
- ERNST, L.F. (1973) – Calculation of transport time for groundwater flow in the saturated zone (in Dutch). *Nota 755 ICW, Wageningen*, 42 pp.
- EXLER, H.J. (1972) – Defining the spread of groundwater contamination below a waste tip. *Conf. on Groundwater Pollution, Univ. of Reading, Vol. I*.
- GOLWER, A., G. MATTHES and W. SCHNEIDER (1969) – Selbstreinigungsvorgänge im aeroben und anaeroben Grundwasserbereich. *Vom Wasser* 36: 64-91.
- HAAN, F.A.M. DE (1975) – Interaction-mechanisms in soil as related to soil pollution and groundwater quality. *Versl. Meded. Comm. Hydrol. Onderz. T.N.O. 21*, p. 34-51.
- STEENVOORDEN, J.H.A.M. and H.P. VAN OOSTEROM (1973) – Nitrogen, phosphate and organic material in ground and surface water in some areas (in Dutch). *Cultuurtechn. Tijdschr.* 12 (6): 1-19.

- SVA (1973) – Report IV. Groundwater pollution in the vicinity of the waste disposal site Ambt Delden (in Dutch). SVA/498, Amersfoort 60 pp.
- (1974) – Report V. Groundwater pollution in the vicinity of the waste disposal site Ambt Delden (in Dutch). SVA/938, Amersfoort 55 pp.
- (1975) – Annual report 1973. SVA, Amersfoort, The Netherlands. 80 pp.
- ZANONI, A.E. (1973) – Potential for groundwater pollution from the land disposal of solid wastes. CRC Critical reviews in Environment Control: 226-260.

SOME QUALITY ASPECTS OF ARTIFICIAL RECHARGE IN SANDY SOIL OF THE VELUWE

F.J.J. BRINKMANN, J. HRUBEC and B.C.J. ZOETEMAN
Government Institute for Water Supply, Voorburg, The Netherlands

1. INTRODUCTION

In the Netherlands the possibilities for abstraction of groundwater for public and industrial water supply are rather limited in relation to the expected increase of the water demand in the coming decades. Therefore additional ways of water supply, such as artificial recharge of riverwater have to be explored.

Artificial recharge of surface water, as a means of water storage, is practised for more than thirty years in the dunes of the Netherlands. The water supplies of Amsterdam, The Hague and the Province North-Holland are mainly based on artificial recharge in dunes. The first two decades this artificial recharge was carried out with water from the Rhine after rapid sand filtration. Recently the water withdrawn from the river Rhine is, at least partly, submitted to a coagulation process before its infiltration in the dunes. Most of the other and smaller dune water supplies also practise or study artificial recharge. In some cases this study includes an extensive pre-purification. Possibly less consciously applied but more intensively used is the purifying capacity of the soil during bank-infiltration. Groundwater abstracted by some Dutch waterworks has to be, at least partly, considered as bank filtered Rhine water.

At present the possibilities of artificial recharge of intensively treated Rhine water in sandy soils in the central part of the Netherlands called the Veluwe, are investigated.* The underground storage of treated riverwater can satisfy the need in periods with a bad quality of the riverwater and during spells with low water flow in the river. Besides this, the quality will be equalized during the detention in the sub-soil. The Minister of Public Health and Environmental Hygiene has established a Committee to advise on the desirability of further investigations. The Committee has initiated several research activities and it is supported by a Technical Working Group. The Working Group covers four Ad-hoc Groups. One of these dealt with geochemical aspects of artificial recharge. The Technical Working Group has also at their disposal the results of experiments in a pilot plant which is in operation in Leiduin, near Amsterdam, since four years as a joint research effort of the National Institute for Water Supply and the Testing and Research Institute of the Netherlands Waterworks Undertakings K.I.W.A. Ltd.

* Extensive information is available in the reprint "saving water sparing Veluwe" H₂O, 8: 295-319, 1975.

In this paper attention is given to the geochemical aspects of infiltration of treated Rhine water in the Veluwe area and the reader is particularly referred to the report of the earlier mentioned Ad-hoc Group on Geochemistry of the Technical Working Group. Some of the data which are presented in this paper are based on the report of the Ad-hoc Group which includes contributions of the Free University of Amsterdam, and of the Institute for Atomic Sciences in Agriculture in Wageningen.

The advise of the Committee to the Minister will be based on evaluations for a so called "hypothetical calculation model" which concerns a recharge project of 100 million m^3 /year capacity. The first reason for the choice of the Veluwe area as a potential re-

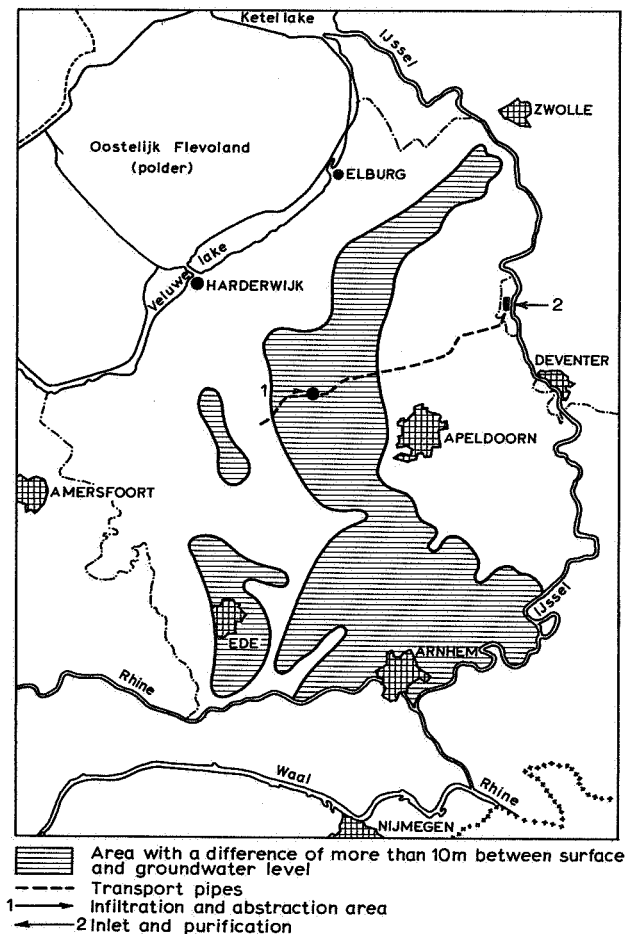

Fig. 1. Situation of the hypothetical project Crown Estate and of areas with a difference of more than 10 meters between groundwater level and surface.

charge location lies in the fact that the groundwater level is, at several areas, far below the surface, up to 30 or 40 and even 70 meters.

In these cases small fluctuations or a raising of the groundwater level with a few meters will have no influence on the vegetation. When striving to a complete regaining of the recharged water without attracting original groundwater it is not possible to avoid any rising of the groundwater level.

Other essential points which were used as pre-conditions for design are the lacking of extensive impermeable layers, a relatively coarse sandy underground, predominantly aerobic conditions and lack of organic material in the underground of at least the flanks of the ice-pushed areas.

Fig. 1 gives an illustration of the areas under consideration. Besides this the Veluwe is conveniently situated in relation to the supplying river. In this largest nature-reservate of the Netherlands ecological aspects as well as the interests of the present-day users of the Veluwe-groundwater also play an important role for the choice of the location of recharge works. For the hypothetic calculation model the Estate of the Crown was chosen as a convenient location. The main reason for introducing the Crown Estate, in the calculation model is the fact that there exist many data about the Crown Estate, more than about other locations. In case the Veluwe recharge project will be realised, a definitive location, which can be different, still has to be selected. The hypothetic calculation model further considers pre-treatment of riverwater consisting of coagulation, sedimentation, biological filtration, ozonisation, secondary flocculation and rapid sand filtration, activated carbon filtration and chlorination.

The treated water should subsequently be transported to the recharge area and be infiltrated in a subsoil with predominantly aerobic groundwater, after which it should be regained and distributed without any further treatment.

A complete regaining of the recharged water is strived for. Exchange with the original water should be avoided as much as possible because of the different characters of infiltrated and original groundwater. When applying excentric infiltration, see fig. 2, the exchange is estimated to be below five percent. This exchange is caused by diffusion, by temporary interruption of the infiltration, by seasonal alterations in the direction of the groundwater flow, by inhomogenities of the sediments and by density differences. It is estimated that the losses of the infiltrate can reach the surface of the soil at the North West border of the Veluwe after several centuries, where hardly any brooks are originating which support important ecological systems.

As a background for ecological evaluation of artificial recharge in the Veluwe area this paper presents a description of the present quality of the groundwater and local rainwater in comparison with the expected quality of the recharge water. Based on these data the possible implications for the quality of the local groundwater and the contamination of the underground are discussed as well as the final quality of the regained infiltrate.

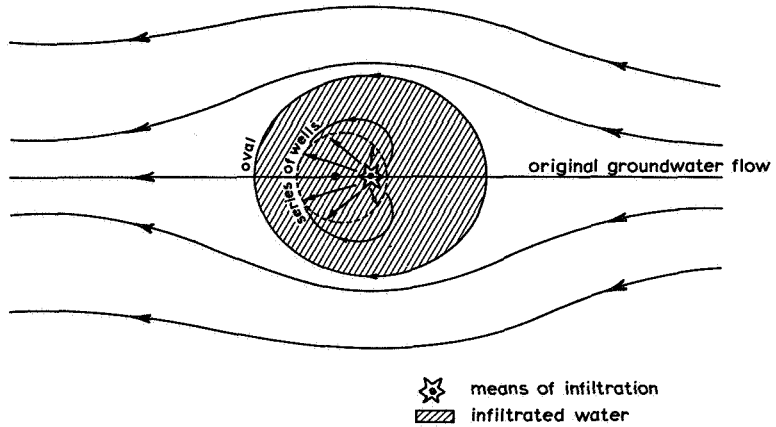

Fig. 2. Upperview on the excentric infiltration system.

2. QUALITY OF THE NATURAL GROUNDWATER

From earlier observations it is clear that the groundwater is not aerobic at every point of the Veluwe area. Water quality analyses for a number of locations are listed in table 1 and 2. Especially in the centers of the ice-pushed areas the situation is often at the threshold of aerobic and anaerobic conditions. To the flanks, which contain coarse sandy deposits, the situation is in general aerobic.

In fig. 3 the water flow in the ice-pushed area is presented schematically. In the center of the ice-pushed area the flow is nearly vertical. Here the detention time is very long, which can be one of the causes of anaerobic conditions.

A second explanation may lie in the coverage with forests in the center of the ice-pushed area. The pre-glacial layers in the center may also contain silty sediments with organic compounds.

For recharging purposes these locations have to be avoided as otherwise a post-treatment of the regained water might become necessary and a serious risk of clogging of

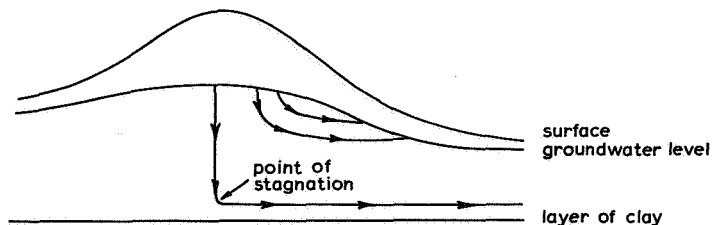

Fig. 3. Water flow in the ice-pushed area.

Table 1. Chemical composition groundwater in mg/l (1969).

x = trace; – = non-aggressive; zw = slight aggressive

Number boring	Estate of the crown									
	Hoge Duvel					Hoenderloo				
	27C-41 (Surface 57,5m + N.A.P.)					330-125 (Surface 52,5 m + N.A.P.)				
Underside filter NAP	-20	-110	-144	-206	.37	.16	-53	-140	-160	-239
Conductivity μ S	128	148	167	196	235	212	141	208	280	287
pH	7,71	7,84	7,85	8,33	7,44	8,01	9,10	8,01	8,70	8,70
KMnO ₄	2	1	2	1				15		12
Cl ⁻	13	14	13	12	19	41	18	15	16	15
NO ₂ ⁻	x	0,04	0	0,02				0		0,30
NO ₃ ⁻	0	x	x	0				0		0
SO ₄ ²⁻	14,4	13,4	18,7	10,9	55,3	97,6	31,9	19,8	16,5	10,3
HCO ₃ ⁻	61	79	84	119	92	122	56	122	180	192
CO ₂	2	2	2	0		2	0	2	0	0
CO ₃ ²⁻							2		3	4
PO ₄ ³⁻	0,10	0,28	0,35	0,19				0,30		0,30
SiO ₂	20,4		21,0	21,0				13,4		12,8
NH ₄ ⁺	0,17	0,27	0,25	0,14				0,38		0,28
org NH ₄ ⁺	0,10	0,10	0,20	0,08				0,30		0,16
Fe	0,13	0,28	0,58	0,04				0,03		0,08
Mn	0,54	0,27	0,22	0,14				x		x
Ca ²⁺	17,0	23,8	24,0	33,0				34,0		11,5
Mg ²⁺	2,4	1,8	3,6	4,1				3,0		6,0
Na ⁺	13	24	14	11,5				19		62
K ⁺	2	1	1	1				2		6
O ₂ (pipet)	0,3	0,3	0	0						
O ₂ (pump)	(3,4)		(0,44)	(2,0)	(11,5)	(9,6)	(6,4)	(1,3)		
Agress. CaCO ₃	zw	zw	zw	–				–	–	–
Tot.hardness °D	2,9	3,8	4,2	5,6	1,5	3,0	2,4	5,5	7,8	3,0
HCO ₃ in °D	2,8	3,6	3,9	5,5	1,5	3,0	2,4	5,5	7,8	3,0

Table 2. Chemical composition groundwater in mg/l (1973-1974)
Sp = trace

Place	Number of boring							
	33D 133				33D 135			
	Vliegbasis Deelen				Loenermark/Apel- doorn			
Filter underside related to surface	-50	-98	-127	-163	-82	-130	-165	-196
Conductivity μS	183	113	110	163	112	72	118	223
pH	3,81	7,09	7,23	7,37	7,01	6,74	7,03	7,60
KMnO ₄	8	1	1	1	2	2	4	13
Cl ⁻	17	11	12	8	16	9	12	9
NO ₂ ⁻	0,12	0	0	0	0	0	0	Sp
NO ₃ ⁻	13,2	Sp	Sp	Sp	2,6	0	0	Sp
SO ₄ ²⁻	24,5	8,2	11,1	11,5	12,6	8,2	6,4	14,4
HCO ₃ ⁻	61	58	52	98	43	27	58	137
PO ₄ ³⁻	0,24	0,02	0,07	0,02	0,40	0,26	0,19	0,54
NH ₄ ⁺	0,44	0,02	0,02	0,02	0,03	0,05	0,05	0,20
Org. NH ₄	0,12	0,02	0,02	0,02	0,02	0,08	0,02	0,08
Fe	0,04	0,06	0,44	0,23	0,07	0,50	4,0	1,2
Mn	0,10	0	0,17	0,11	0,03	0	0,43	0
Na ⁺	20,2	9,9	12,7	7,8	20,2	10,6	13,8	25,5
O ₂	5,5	0,13	0,15	-	9,1	6,6	0,4	-
Total hardness °D	3,7	2,8	2,6	4,8	1,6	1,1	2,3	4,7

wells as a result of mixing aerobic and anaerobic water and deposition of e.g. Iron (III) hydroxide may occur.

Because of the large differences in water quality it is only possible to characterise the Veluwe groundwater quality within very wide limits.

The hardness of the original Veluwe groundwater lies seldom above 2 meq/l, the chloride content is always between 10 and 20 mg/l, the sulfate concentration is in general between 5 and 25 mg/l. The nitrate content is low or nil, in the upper layer of the saturated zone, however, high values can occur due to activities of men. The iron content is usually below 1 mg/l, in the flanks of the ice-pushed areas the iron-content of the groundwater can be lower than 0,1 mg/l. The potassiumpermanganateconsumption of the water is very low and in the order of 1 à 2 mg/l.

Table 3. Concentrations of trace elements in original Veluwe groundwater

Element	Concentration in $\mu\text{g/l}$	
	Upper layers of groundwater	Deep groundwater, more than 80 m deep
Beryllium	0,1-0,5	0,1-0,5
Cadmium	0,1-1,0	0,1-2,0
Chromium	< 1-5	1-5
Cobalt	0,5-3,0	1
Copper	2-50	2-50
Lead	1-25	5-25
Lithium	1-5	1-3
Nickel	1-12	1-12
Vanadium	2-8	2-10
Zinc	5-150	25-200

In table 3 the observed contents of trace elements in the Veluwe groundwater are given in comparison with the trace element content of the infiltration water.

No data on pesticides are available for the Veluwe groundwater. A point of orientation can be found in the values measured in groundwater at Bilthoven (Greve, 1974). The detection limit of $0,01 \mu\text{g/l}$ for chlorinated pesticides was not exceeded in this water. Also choline-esterase inhibitors could not be detected. It is estimated that the total of six polynuclear aromatic hydrocarbons does not exceed a value of 50 nanograms/liter in the original groundwater.

3. QUALITY OF TREATED RHINE WATER BEFORE ARTIFICIAL RECHARGE

The expected quality of the treated Rhine water as described in the report of the Ad-hoc Group on Treatment is summarized in table 4. This table shows that the quality of the treated water is comparable to that of drinking water.

After treatment and transport to the Veluwe area the water can be recharged using:

- open infiltration by means of ponds or canals
- closed infiltration by tunnels
- injection by wells.

The method of recharge is important for the possible recharge rate, which should be between 3-30 m/day in case of infiltration via canals or tunnels, and for the quality of the recharge water, as algae growth may occur in open infiltration ponds. Even at the expect-

Table 4. Average quality of Rhine water and treated Rhine water prior to artificial recharge

Parameter	Unit	Rhine water (1970-1973)	Water before recharge (prognosis)
Odour Number	dil	35	0,1
Oxygen	% sat.	60	> 90
Total organic carbon	mgC/l	10	3
Ammonium (incl. org. NH ₄)	mgNH ₄ /l	4,5	0,05-0,2
Chloride	mgCl/l	150	180
Nitrate	mgNO ₃ /l	12	20
Phosphate (ortho)	mgPO ₄ /l	0,85	0,03
Potassium	mgK/l	10	10
Sodium	mgNa/l	65	80
Sulphate	mgSO ₄ /l	80	100
Total hardness	meq/l	5,5	
Arsenic	mg/l	0,01	0,003
Cadmium	mg/l	0,005	0,0005
Chromium	mg/l	0,06	0,002
Cobalt	mg/l	0,004	0,0005
Copper	mg/l	0,03	0,01
Iron	mg/l	1,5	0,03
Lithium	mg/l	0,03	0,03
Lead	mg/l	0,035	0,005
Manganese	mg/l	0,2	0,01
Mercury	mg/l	0,0025	0,0002
Vanadium	mg/l	0,01	0,005
Zinc	mg/l	0,2	0,04
Cholinesterase inhibitors	mg/l.P.O.	0,005	< 0,00001
Hexachlorobenzene	mg/l	0,00015	0,00001
Lindane	mg/l	0,00015	0,00005
Oil	mg/l	0,5	0,01
Phenols (volatile)	mg/l	0,03	0,0005
Polynuclear Hydrocarbons	mg/m ³	1	0,05

ed low phosphate levels algae growth may be the cause of reduced recharge rates and increased maintenance activities. A factor enhancing growth can be the nutrients released from excrements of birds.

The influence of deposition of leaves in a recharge pond has been studied also. It is estimated that even for the first day of deposition less than 1 mgO₂/l of additional biological oxygen demand will be associated with complete conversion of the organic materials which are released from the leaves.

In the case of infiltration of aerated water at the rate of more than 5m/day, deposition of leaves in infiltration ponds cannot be a serious threat to the aerobic condition of the recharged water.

Besides several disadvantages of open recharge it has the advantages of low cost and simple maintenance.

4. POSSIBLE INFLUENCES ON GROUNDWATER QUALITY

As a basis for a prognosis in relation to the groundwater quality in the vicinity of the artificial recharge works the absence of peaty layers in the underground has been supposed, although lenses of clay may occur incidentally. Locally organic material can be present. In the flanks of the ice-pushed areas however this occurrence is only limited. It seems permitted to restrict the considerations to infiltration under aerobic conditions in sandy soil.

Table 5. Quality of mixed groundwater near the infiltration point and of original groundwater

Parameter	Concentration in mg/l	
	Water near infiltration point for 5% loss	Original groundwater
Ammonia (incl. alb. ammonia)	0,3	0,3-0,4
Chloride	100	10 à 20
Hydrogen carbonate	90-140	50-150
Iron	0,06-0,012	0,1-0,2
Manganese	0-0,2	0-0,2
Nitrate	10-11	trace
Phosphate	0,03	0,03
Potassium	5-8	1-5
Sodium	45-55	10-25
Sulphate	60	15

This implicates however that the location of the artificial recharge works has to be selected very carefully. In case a maximum quantity of 5% of the infiltrated water is exchanged and mixed with an equal volume of original groundwater an evaluation, as presented in table 5, can be given of the resulting groundwater quality, which flows to the N-W boundaries of the Veluwe.

The quality prognosis for the lost "groundwater mixed infiltrate" is also based on the knowledge of the behaviour of the water constituents as resulting from the Leiduin Pilot Plant and from the practice of dune infiltration.

For ions like chloride, sodium and potassium no conversion will take place and if the exchange with clayminerals is neglectable the concentrations in the lost mixed infiltrate can be calculated on a simple basis of blending.

Conversion of ammonium, nitrate or sulfate may take place under certain conditions, but because of the character of the recharge water it is also allowed to neglect this conversion. It is clear that the phosphate concentration will be at a very low level and below 0,03 mg/l of phosphate. The prognosis for hydrogencarbonate is based on the lack of biogenic carbon dioxide production. As long as no iron is dissolved from the underground, recharge will result in a slightly decreased iron concentration in comparison with the original groundwater quality.

Trace elements, apart from lithium, have hardly to be taken into account. Their concentrations in the infiltrate reach, thanks to the extensive pre-treatment, a level equal to or below the natural level. This is shown in table 3 and 4 together.

As γ -H.C.H. (Lindane) is the most abundantly occurring pesticide in surface water while H.C.B. (hexachlorobenzene) is to mention as the second one, the prognoses for the chlorinated pesticides have been restricted to these two compounds. Their concentrations in recharge water and in original groundwater are extremely low or undetectable.

For choline-esterase inhibitors the same appears. Thanks to the pre-treatment recharge will not significantly influence the polycyclic aromatic hydrocarbon content of the groundwater.

Alterations in the quality of the groundwater by leakage of the infiltrate are only possible in a very restricted sheet of groundwater, situated in the neighbourhood of the infiltration point and deep under the surface.

This water can percolate at a very restricted scale and after a very long detention period to the border of the Veluwe. In case some diffusion occurs during this detention hardly any change in concentration may be observable when percolating.

5. EXPECTED QUALITY OF THE REGAINED WATER

For most of the cations and anions the level in the water, which is abstracted from the Veluwe after an average detention period of 12-24 months, is expected to be equal to the quality of the infiltrated water.

As far as nitrate is concerned, a slight improvement from 20 mg/l to about 15 mg/l is possible. Also for ammonia small changes in the concentration can be expected. The organic carbon content will be lower after the detention in the underground due to biological mineralisation of the organic compounds. When infiltrating extensively treated Rhine water in the Leiduin Pilot Plant, in 4 meter columns of sand, the Total Organic Carbon content of the water was reduced from 2.1 mg/l till 1.8 mg/l.

The infiltration will not have a significant influence on the cadmium-, cobalt-, lead- and vanadium concentration. The abstracted water will show a further decrease as for the contents of arsenic, beryllium, chromium, copper, mercury, lithium, nickel and zinc.

6. CONTAMINATION OF THE UNDERGROUND AND BOTTOM

Due to adsorption and deposition of solid particles water contaminants can accumulate in the underground.

As long as this accumulation takes place only in the first centimeters of the soil it will be possible to remove the contaminated soil by mechanical means. Therefore the more deep penetrating contaminants are of special importance.

From experiments in the Leiduin Pilot Plant it can be concluded that the main part of the accumulated organic material, as measured by the KMnO_4 -consumption, is located in the upper few centimeters of the sand, as illustrated in figure 5.

Table 6 illustrates for artificial recharge carried out in the Leiduin Pilot Plant that during replenishment a reduction takes place of the concentration of beryllium, chromium, copper, lithium and zinc. This indicates a possible accumulation of these elements in the ground, which occurs especially in the first 5 cm of the sand column (see fig. 4).

Table 6. Removal of trace elements from the water phase during infiltration of extensively treated Rhine water (expressed in $\mu\text{g/l}$).

Parameter	Before recharge	After recharge
Beryllium	0,3	0,2
Cadmium	1,3	1,3
Chromium	0,9	0,6
Cobalt	2	2
Copper	4,5	2,2
Lead	6,7	6,7
Lithium	16	11
Nickel	10	6,5
Vanadium	6,3	5,8
Zinc	77	18

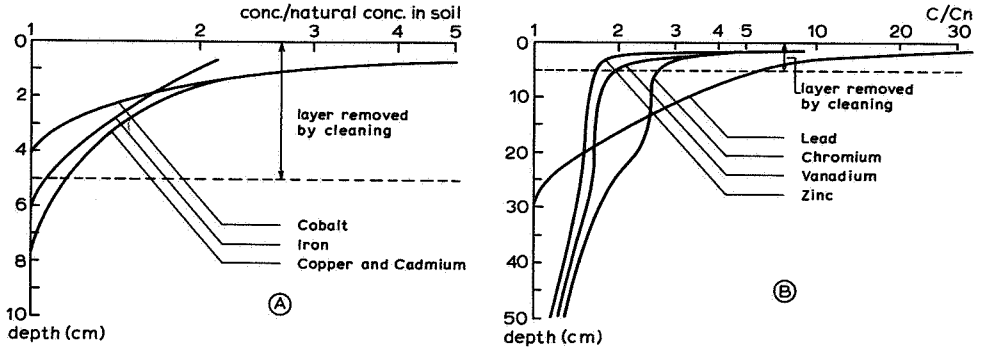

Fig. 5. Soil contamination by metals after infiltration of quality I water.

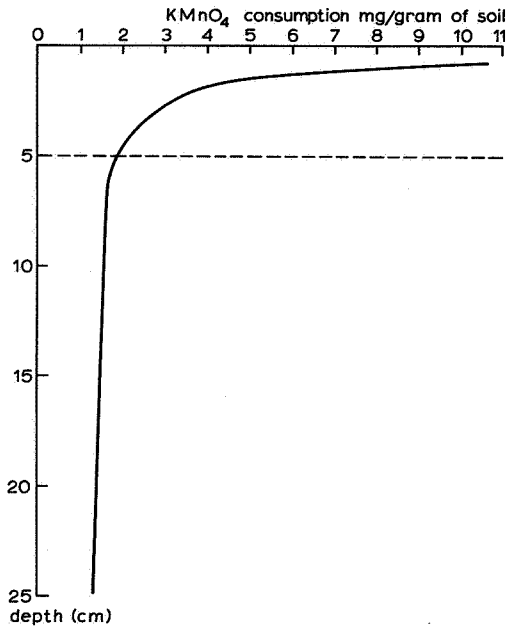

Fig. 4. Soil contamination by organic matter after infiltration of quality I water.

Consequently mechanical cleaning of the surface can remove most of the accumulated elements.

7. QUALITY CHARACTERISTICS OF LOCAL RAINWATER

Naturally the Veluwe aquifer is fed by local precipitation. For evaluation of the consequences of artificial recharge on the quality of the groundwater it is also necessary to compare the infiltrate quality with the present quality of the local rainwater. For this purpose rainwater was collected at Epe during alternatively three and four days. Table 7 summarizes the results.

Table 7. Average quality of rainwater at Epe in 1975

Parameter	Unit	Concentration value	Number of data
pH		4,2-6,9	14
Conductivity	$\mu\text{S/cm}$	34	13
KMnO ₄ -consumption	mgKMnO ₄ /l	4,0	7
Total Organic Carbon	mgC/l	1,8	19
Ammonium	mgNH ₄ /l	1,05	17
Chloride	mgCl/l	7,1	15
Nitrite	mg/NO ₂ /l	0	2
Nitrate	mgNO ₃ /l	0,7	13
Phosphate	mgPO ₄ /l	0,15	13
Sulphate	mgSO ₄ /l	6,4	8
Beryllium	mg/l	< 0,00005	14
Cadmium	mg/l	0,001	30
Chromium	mg/l	0,0009	20
Cobalt	mg/l	< 0,0005	20
Copper	mg/l	0,005	20
Iron	mg/l	0,03	17
Lead	mg/l	0,01	20
Lithium	mg/l	< 0,001	11
Manganese	mg/l	0,008	15
Mercury	mg/l	0,0004	5
Nickel	mg/l	0,005	18
Vanadium	mg/l	0,005	14
Zinc	mg/l	0,26	20

Comparison of the data of table 7 with those of the expected quality of the water prior to recharge shows that infiltration may lead to elevated levels in the groundwater for some ions like chloride, sulphate and nitrate only.

SUMMARY

Based on aerobic artificial recharge of pretreated Rhine water in a sandy soil some geochemical aspects of a hypothetical recharge project in the Veluwe are described on the basis of a report of the Ad-hoc Group Geochemistry of the Technical Working Group for Artificial Recharge in the Veluwe area. The hypothetical project considers a closed recharge-abstraction system with a maximum loss exchange to the groundwater of recharged water of 5% of the production capacity. It is expected that locally limited increases in concentration might occur for some ions like sodium, chloride and nitrate in the groundwater in the vicinity of the location of recharge which may finally reach the surface at the border of the Veluwe.

As a result of the extensive pretreatment prior to artificial recharge no increased levels in the groundwater will occur for the trace elements, pesticides and polynuclear hydrocarbons. Although some trace elements, like chromium and zinc, have a tendency to accumulate in the upper layer of the soil, this can be easily removed by mechanical means in cases of infiltration by means of ponds or underground canals.

As it is likely that anaerobic conditions or contact with anaerobic water can be avoided, the regained water can be assumed to be of drinking water quality. In this case no additional treatment might be necessary before distribution.

LITERATURE

- GREVE, P. (1974) – Personnel communication.
- HRUBEC, J. (1973) – Proefinstallatie voor infiltratie in Veluwe en duinen te Leiduin. *H₂O*, 6: 589.
- LIPS, H.J.M., B. BULTEN and J. VAN PUFFELEN (1969) – Kwaliteitsverandering bij de infiltratie in de duinen. W.I.R.D.U. (Working Group Infiltration Riverwater in the Dunes).
- PUFFELEN, J. VAN (1972-1973) – Kwaliteitsverandering bij de infiltratie van Rijnwater in de duinen. Stichting Post-akademiale Vorming, Gezondheidstechniek, T.H. Delft.
- REPORT OF THE AD-HOC WORKING GROUP GEOCHEMISTRY (1975) – Technical Committee Veluwe Infiltration. Secr.: Government Institute for Water Supply, Voorburg.
- ROMIJN, E., P.J. VERKERK, M. ZWIJENBURG-DE RIJKE, H. VAN DAM and J. HRUBEC (1975) Water sparen, Veluwe sparen. *H₂O*, 8: 295-319 (Engl. abstr).
- ZOETEMAN, B.C.J. (1972-1973) – Infiltratie in de Veluwe na uitgebreide voorbehandeling. Stichting Postakademiale Vorming, Gezondheidstechniek, T.H. Delft.
- ZOETEMAN, B.C.J., J. HRUBEC and F.J.J. BRINKMANN (in press.) – Water quality management aspects of the Veluwe artificial recharge plan. Water Treatment and Examination.

COMMITTEE FOR HYDROLOGICAL RESEARCH T.N.O.

Proceedings and Informations

- No. 1. Proceedings of Technical Meetings 1—6 (with summaries in English), 1952.
1. Investigations into the water balance of the Rottegataspolder
 2. The water supply for crops I
 3. Observations of groundwater levels
 4. Investigations by drain gauges in the Netherlands
 5. The water supply for crops II
 6. The problem of the increasing salinity of ground and surface water in the Netherlands
- No. 2. Proceedings of Technical Meetings 7—10 and Report on the evaporation research in the Rottegataspolder 1947-1952 (with summaries in English), 1955.
7. The study of precipitation data
 8. Model research on groundwater flows
 9. Measurements and improvement works in basin of brooks
 10. Geo-electrical research
- No. 3. Proceedings of Technical Meetings 11—12 (with summaries in English) and Report on the lysimeters in the Netherlands (in English), 1958.
11. The water supply of sandy soils
 12. Quality requirements for surface waters
- No. 4. Evaporation Symposium and Report on the Lysimeters in the Netherlands II (with summaries in English), 1959.
- No. 5. Proceedings of Technical Meetings 13—14 (with summaries in English), 1960.
13. Groundwater levels and groundwater movement in the sandy areas of the Netherlands
 14. Water in unsaturated soil
- No. 6. Proceeding of Technical Meeting 15 (with summaries in English and French, 1961.
The regimen of the Rhine, the Ysselmeer and Zeeland lake

- No. 7. Proceeding of Technical Meeting 16 (with summaries in English), 1962.
The dry year 1959
- No. 8. Proceeding of Technical Meeting 17 (with summaries in English), 1963.
The laws of groundwater flow and their application in practice
- No. 9. Proceeding of Technical Meeting 18 (with summaries in English), 1963.
Water nuisance
- No. 10. Steady flow of ground water towards wells, compiled by the Hydrologisch
Colloquium (in English), 1964.
- No. 11. Proceeding of Technical Meeting 19 (with summaries in French and German),
1964.
Geo-hydrological cartography
- No. 12. Proceeding of Technical Meeting 20 (in English), 1966.
Water balance studies
- No. 13. Proceeding of Technical Meeting 21 (in English), 1966.
Recent trends in hydrograph synthesis
- No. 14. Proceeding of Technical Meeting 22, 1968.
Precipitation Data (II) and
Report on the Lysimeters in the Netherlands (III) (both with summaries in
English)
- No. 15. Proceedings and Informations no. 15 (in English), 1969.
Soil — Water — Plant
Proceeding of Technical Meeting 23, 1968.
See page
(Will not be published).
Proceeding of Technical Meeting 24, 1970.
Flow in the unsaturated zone
(Will not be published).
- No. 16. Proceeding of Technical Meeting 29 (with summaries in English), 1975.
Hydrological investigations for masterplan for the future watersupply in The
Netherlands

- No. 17. Proceeding of Technical Meeting 25 (in English), 1973.
Automatic Processing of Hydrological Data
- No. 18. Proceeding of Technical Meeting 26 (in English), 1974.
Hydraulic Research for water management
- No. 19. Proceeding of Technical Meeting 27 (in English), 1974.
The hydrological Investigation Programme in Salland (The Netherlands)
- Proceeding of Technical Meeting 28, 1973.
Water quality of Dutch rivers with respect to water management
(Will not be published).
- No. 20. Proceeding of Technical Meeting 30, 1974.
Salt distribution in estuaries
(Is not yet published).
- No. 21. Proceeding of Technical Meeting 31, 1976.
Groundwater Pollution

COMMISSIE VOOR HYDROLOGISCH ONDERZOEK T.N.O.

Verslagen en Mededelingen

- No. 1. Verslagen van de Technische Bijeenkomsten 1–6 (with summaries in English, avec des résumés en français), 1952.
1. Het waterhuishoudkundig onderzoek in de Rottegatpolder
 2. De watervoorziening der gewassen I
 3. Waarneming van grondwaterstanden
 4. Lysimeteronderzoek in Nederland
 5. De watervoorziening der gewassen II
 6. Het vraagstuk van de verzouting van grond- en oppervlaktewater in Nederland
- No. 2. Verslagen van de Technische Bijeenkomsten 7–10 en Verslag inzake het verdampingsonderzoek in de Rottegatpolder over de jaren 1947-1952 (with summaries in English, avec des résumés en français), 1955.
7. Bewerking van regenwaarnemingscijfers
 8. Modelonderzoek van grondwaterstromingen
 9. Metingen en verbeteringen in het stroomgebied van beken
 10. Geo-electrisch bodemonderzoek
- No. 3. Verslagen van de Technische Bijeenkomsten 11–12 (with summaries in English, avec des résumés en français) en Rapport inzake de lysimeters in Nederland (in de Engelse taal), 1958.
11. Watervoorziening van zandgronden
 12. Kwaliteitseisen van oppervlaktewater
- No. 4. Verdampingssymposium Agrohydrologisch Colloquium C.O.L.N. en Rapport inzake de lysimeters in Nederland II (with summaries in English), 1959.
- No. 5. Verslagen van de Technische Bijeenkomsten 13–14 (with summaries in English), 1960.
13. Grondwaterstanden en grondwaterbeweging in de Nederlandse zandgronden
 14. Het water in onverzadigde grond

- No. 6. Verslag van de Technische Bijeenkomst 15 (with summaries in English, avec des résumés en français), 1961.
Enige onderzoekingen ten behoeve van de grondslagen van het beheer van de Rijn, het IJsselmeer en het Zeeuwse Meer
- No. 7. Verslag van de Technische Bijeenkomst 16 (with summaries in English), 1962.
Het droge jaar 1959
- No. 8. Verslag van de Technische Bijeenkomst 17 (with summaries in English), 1963.
De stromingswetten van het grondwater en de toepassing daarvan in de praktijk
- No. 9. Verslag van de Technische Bijeenkomst 18 (with summaries in English), 1963.
Wateroverlast
- No. 10. Steady flow of ground water towards wells, compiled by the Hydrologisch Colloquium, 1964.
- No. 11. Verslag van de Technische Bijeenkomst 19 (avec des résumés en français, mit Zusammenfassungen in Deutsch), 1964.
Geo-hydrologische karteringen
- No. 12. Proceeding of Technical Meeting 20 (in English), 1966.
Water balance studies
- No. 13. Proceeding of Technical Meeting 21 (in English), 1966.
Recent trends in hydrograph synthesis
- No. 14. Verslag van de Technische Bijeenkomst 22, 1968.
Regenwaarnemingscijfers (II) en
Rapport inzake Lysimeters in Nederland (III) (both reports with summaries in English)
- No. 15. Proceedings and Informations no. 15 (in English), 1968.
Soil – Water – Plant
Verslag van de Technische Bijeenkomst 23, 1968.
Kwelverschijnselen
(Wordt niet gepubliceerd).

Verslag van de Technische Bijeenkomst 24, 1970.
Stroming door de onverzadigde zone van de bodem
(Wordt niet gepubliceerd).

No. 16. Verslag van de Technische Bijeenkomst 29 (with summaries in English), 1975.
Het hydrologische onderzoek ten behoeve van het Structuurschema
Drink- en Industrierwatervoorziening Nederland

No. 17. Proceeding of Technical Meeting 25 (in English), 1973.
Automatic Processing of Hydrological Data

No. 18. Proceeding of Technical Meeting 26 (in English), 1974.
Hydraulic Research for water management

No. 19. Proceeding of Technical Meeting 27 (in English), 1974.
The hydrological investigation Programme in Salland (The Netherlands)

Verslag van de Technische Bijeenkomst 28, 1973.
Kwaliteitsaspecten van het Nederlandse oppervlaktewater in relatie tot de
waterhuishouding
(Wordt niet gepubliceerd).

No. 20. Proceeding of Technical Meeting 30 (in English), 197..
Salt distribution in estuaries
(Is nog niet verschenen).

No. 21. Proceeding of Technical Meeting 31 (in English), 1976.
Groundwater pollution

